

(NOTE: DESIGNER LOCKER SHOWN WITHOUT SIDE PANEL OR SLOPING HOOD. PLEASE ORDER SEPARATELY.)

MODEL #32368
 12" WIDE DOUBLE TIER
 DESIGNER WOOD LOCKER – 3 WIDE

(6) LOCKER COMPARTMENTS
 EACH COMPARTMENT:
 10-3/4" W x 34-3/4" H x 16-3/4" D

SIDE VIEW

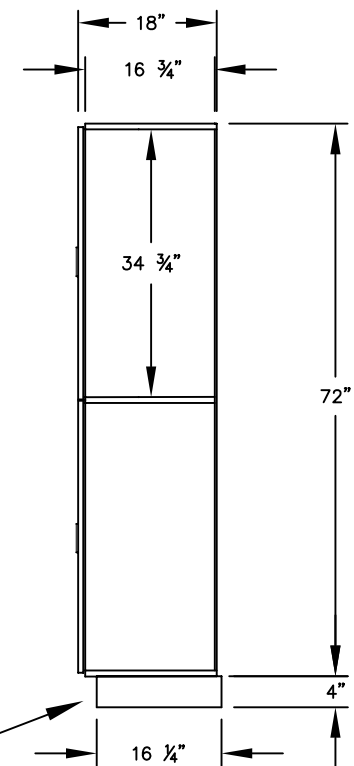

(BASES ARE MADE OF INDUSTRIAL GRADE PARTICLEBOARD AND ARE COVERED IN A DURABLE BLACK LAMINATE. PLEASE SET BASE TO ALLOW 5/8" BETWEEN THE BACK OF THE LOCKER AND THE WALL FOR AIR VENTILATION.)

MODEL #32368

12" WIDE DOUBLE TIER
 DESIGNER WOOD LOCKER
 SIX FEET HIGH (ADD 4" FOR BASE)

AVAILABLE FINISHES: GRAY, BLUE, BLACK,
 MAPLE, CHERRY OR MAHOGANY

DRAWN: 3/2020

Established in 1936, Salsbury Industries is the industry leader in manufacturing and distributing quality lockers.

18300 CENTRAL AVENUE
 CARSON, CA 90746-4008
 PHONE: (800) 562-5377
 FAX: (800) 562-5399