

**MODEL #30024**  
**24" WIDE DESIGNER WOOD**  
**OPEN ACCESS LOCKER**

OVERALL DIMENSIONS:  
 24" W x 72" H x 24" D

SIDE VIEW

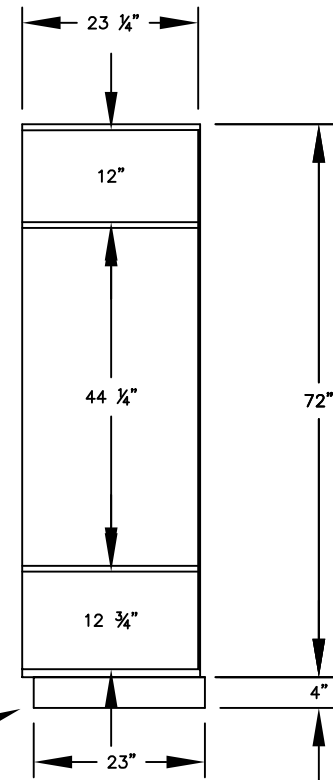

(BASES ARE MADE OF INDUSTRIAL GRADE PARTICLEBOARD AND ARE COVERED IN A DURABLE BLACK LAMINATE. PLEASE SET BASE TO ALLOW  $\frac{5}{8}$ " BETWEEN THE BACK OF THE LOCKER AND THE WALL FOR AIR VENTILATION.)

**MODEL #30024**

24" WIDE DESIGNER WOOD  
 OPEN ACCESS LOCKER  
 SIX FEET HIGH (ADD 4" FOR BASE)

AVAILABLE FINISHES: GRAY, BLUE, BLACK,  
 MAPLE, CHERRY OR MAHOGANY

DRAWN: 3/2020

***Established in 1936, Salsbury Industries is the industry leader in manufacturing and distributing quality lockers.***

18300 CENTRAL AVENUE  
 CARSON, CA 90746-4008  
 PHONE: (800) 562-5377  
 FAX: (800) 562-5399