

Cantina Picnic Table

For Fastener Pack
(FP-CNT-CU-01)

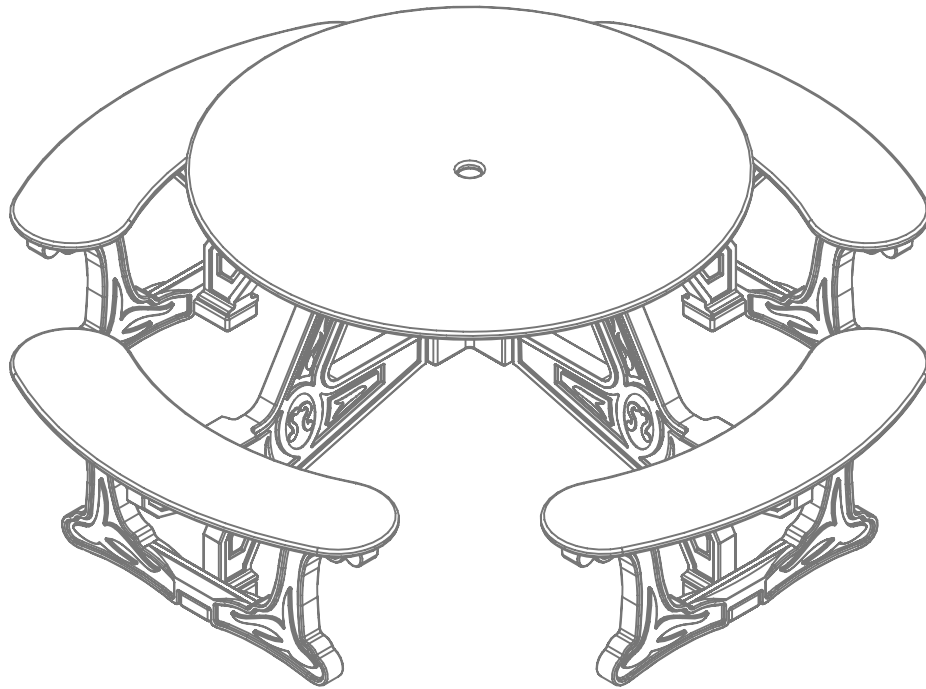

Congratulations !!

You have just purchased the finest recycled plastic picnic table available. Enjoy !!!

Before assembly, please make sure all components are included.

J - Table Top

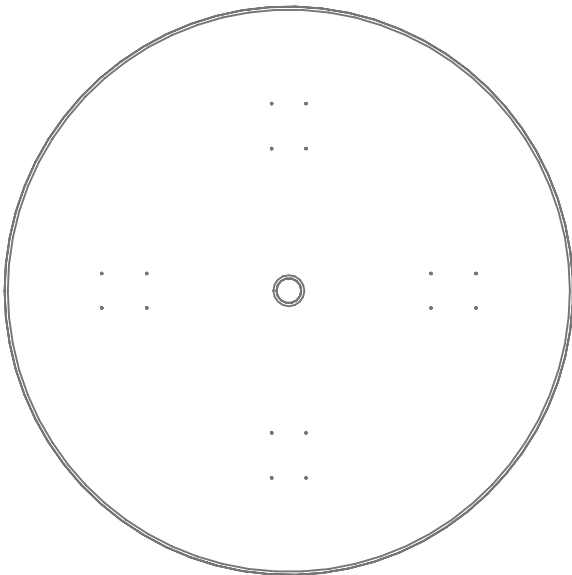

(1) - One Table Top
GSP-CNT-A-01



(1) - One Fastener Pack
FP-CNT-CU-01

FP - Fastener Pack

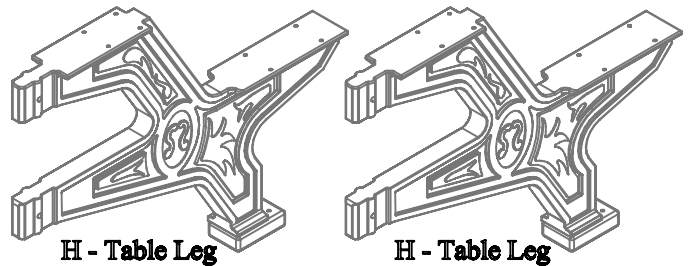

H - Table Leg

H - Table Leg

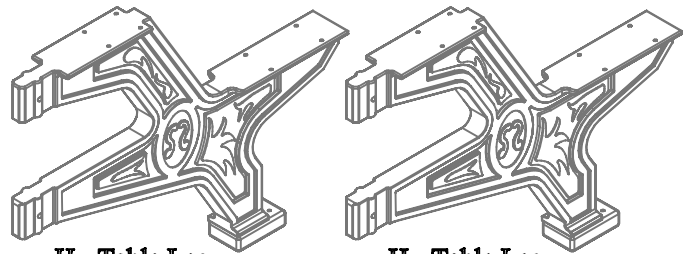

H - Table Leg

H - Table Leg

(4) - Four Table Legs
GSSA-PZ-C-01

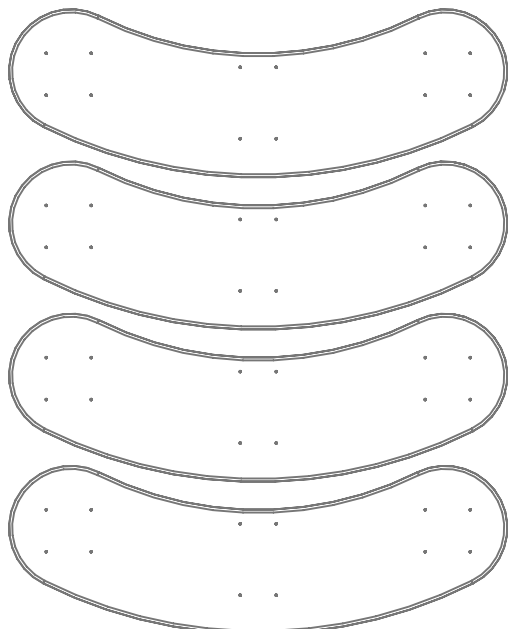

(4) - Four Seats
GSP-CNT-B-01

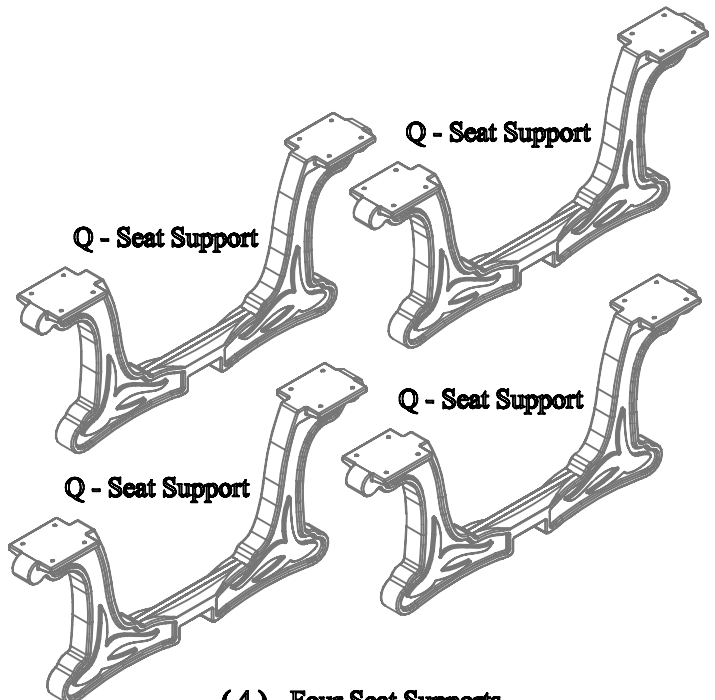

Q - Seat Support

Q - Seat Support

Q - Seat Support

Q - Seat Support

(4) - Four Seat Supports
PS-GSSS-A-01

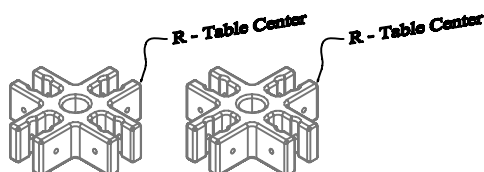

R - Table Center

R - Table Center

(2) - Two Table Centers
PS-GSCS-A-01

Before assembly, please make sure all fasteners are included.

8 - 3/8" x 4 1/2" Hex Head Bolt



16 - 3/8" Flat Washer

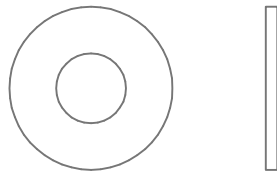

8 - 3/8" Nylon Lock Nut



8 - #12 x 3" Flat Head Phillips Screw



32 - #12 x 1-1/4" Flat Head Phillips Screw



32 - #12 x 1" Pan Head Phillips Screw



Also needed for this assembly will be the following materials:

1 - #3 Phillips Drive Bit

2 - 9/16" Socket Wrench

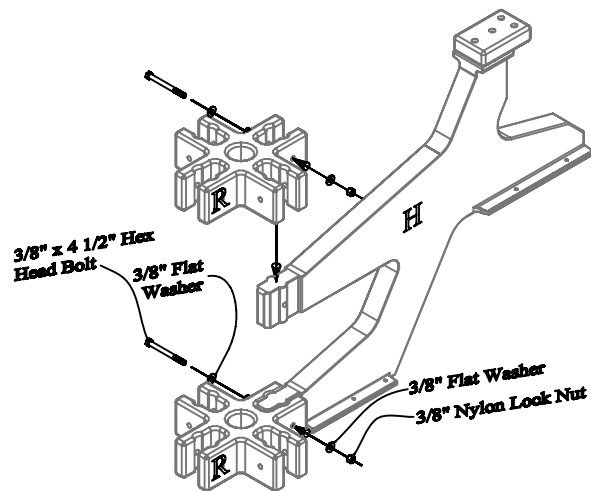

Step #1:

Slide (1) One Table Center onto each end of the Table Leg as shown above. Use (1) One 3/8" x 4 1/2" Hex Head Bolt and (1) One 3/8" Flat Washer along with (1) One 3/8" Flat Washer and (1) One 3/8" Nylon Lock Nut per hole to secure.

Do not tighten bolts completely. This will be done in a later step.

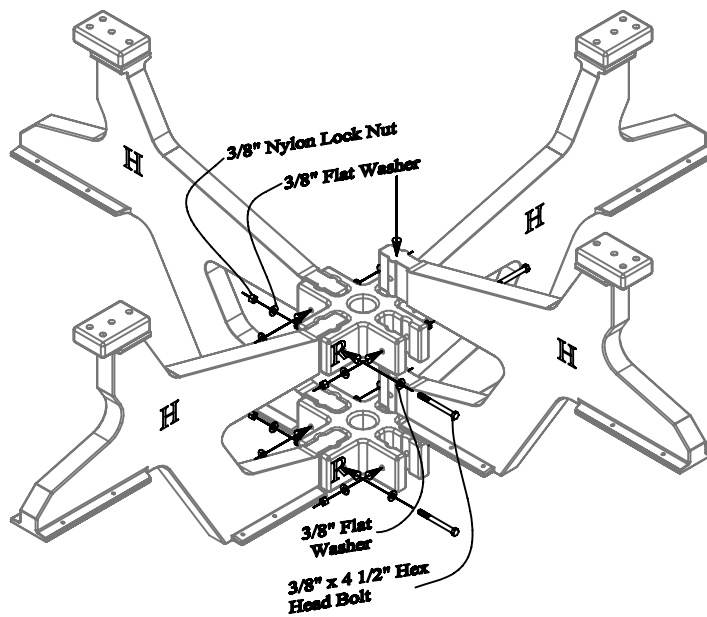

Step #2:

Slide the remaining (3) Three Table Legs in to the Table Centers. Use (1) One 3/8" x 4 1/2" Hex Head Bolt and (1) One 3/8" Flat Washer along with (1) One 3/8" Flat Washer and (1) One 3/8" Nylon Lock Nut per hole to secure.

Do not tighten bolts completely. This will be done in a later step.

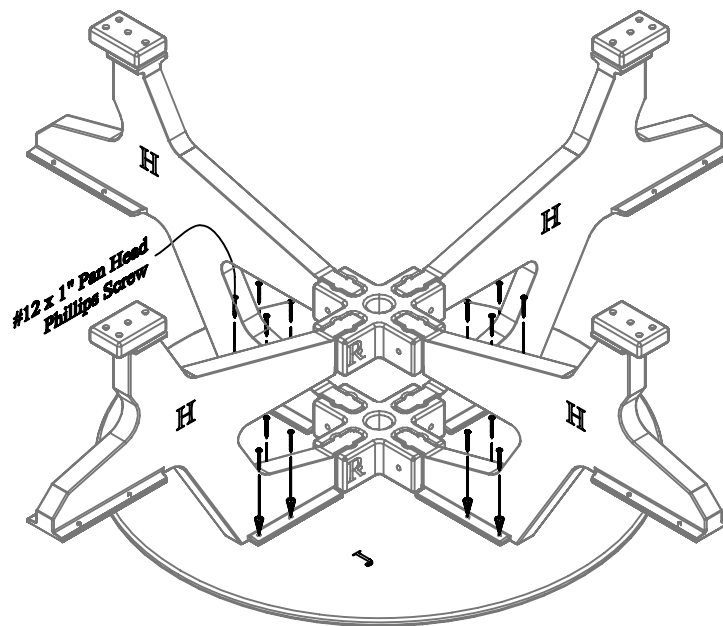

Step #3:

Place the Table Top upside down onto a piece of cardboard or another soft surface to protect it during installation. Place the leg assembly onto the Table Top as shown above. Align the pre-drilled holes in the Table Legs with the pilot holes in the Table Top. Use (1) One #12 x 1" Pan Head Screw per hole to secure.

Be sure to tighten all screws and bolts after completing this step.

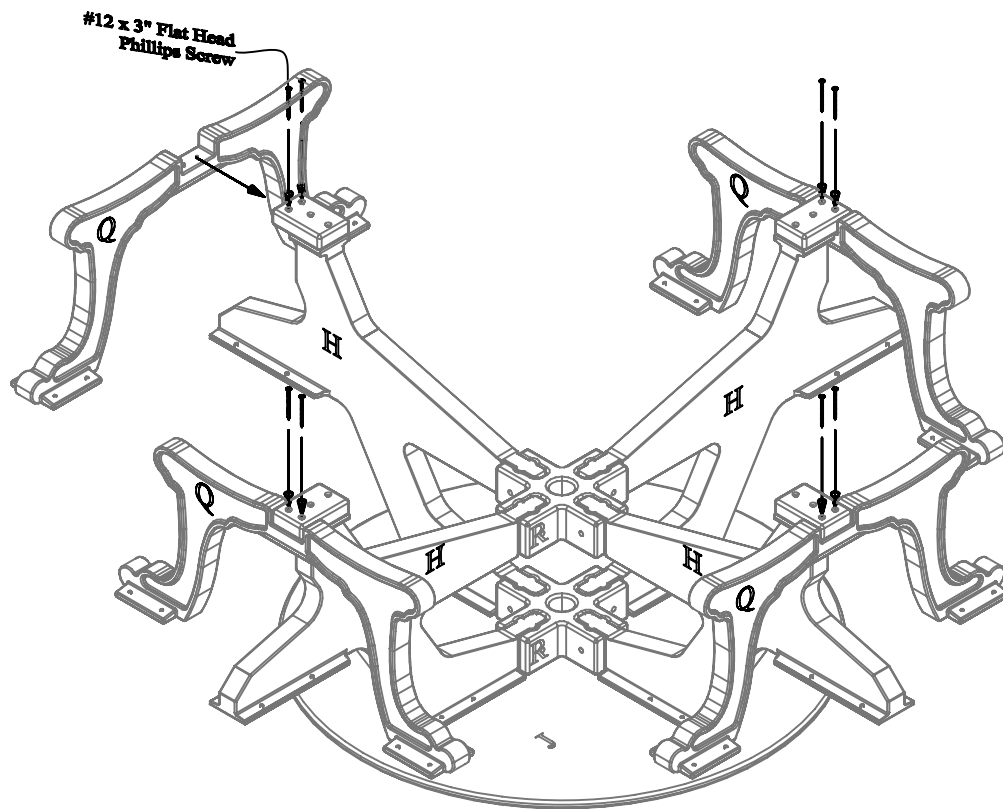

Step #4:

While the table is upside down, align the pre-drilled holes in the Table Leg to the pilot holes in the Seat Support as shown above. Use (1) One #12 x 3" Flat Head Screw per hole to secure.

Do not tighten screws completely. This will be done in a later step.

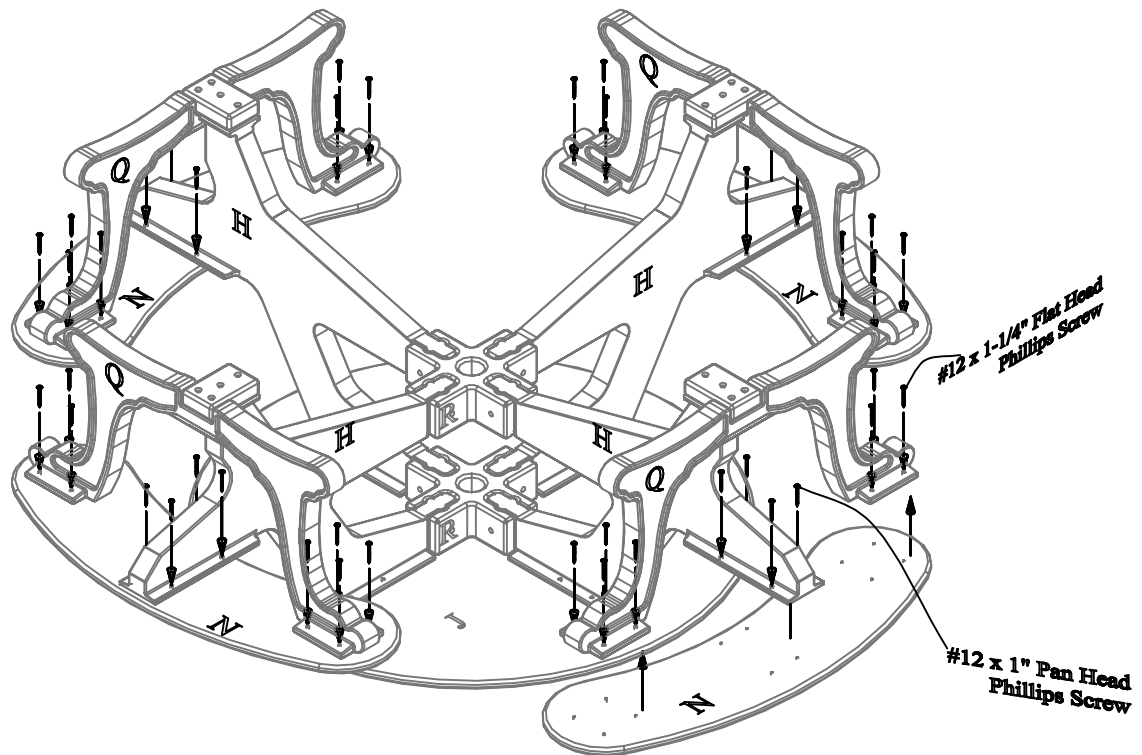

Step #5:

While the table is upside down, align the pre-drilled holes in the Seat to the pilot holes in the Table Leg as shown above. Use (1) One #12 x 1" Pan Head Screw per hole to secure.

Align the pre-drilled holes in the Seat to the pilot holes in the Seat Support as shown above. Use (1) One #12 x 1-1/4" Flat Head Screw per hole to secure.

Be sure to tighten all loose screws after completing this step.

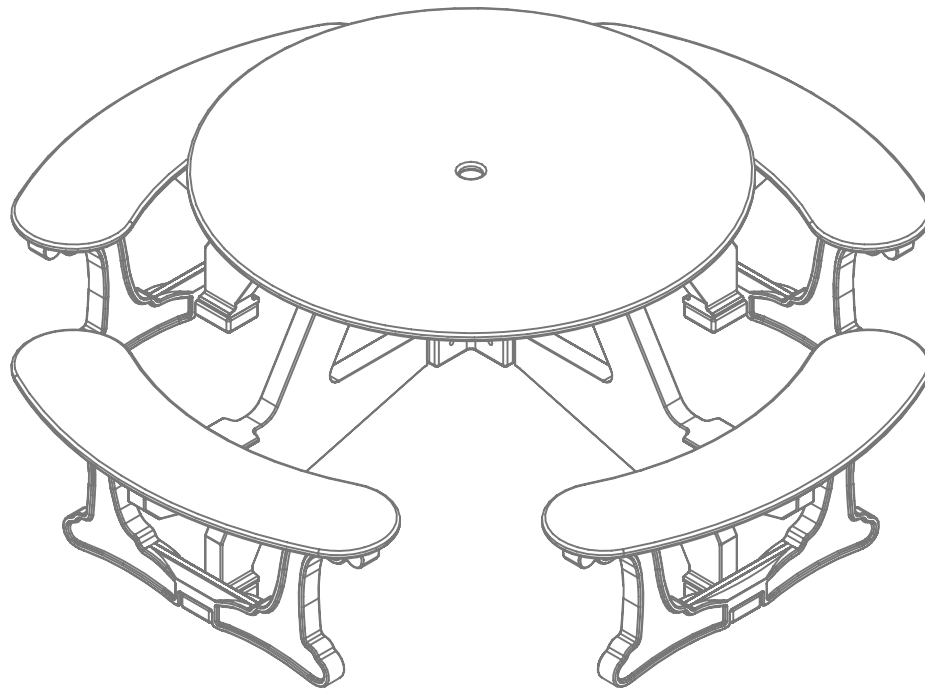

Step #6:

Turn the table over on to its legs, please use caution for the table weighs approximately 190 pounds.