

# Mobile Board Instructions

06/19/17

**Note:** After assembly, peel the protective film from both sides of the board.

**Cleaning Tip:** A mild dish washing liquid can be used with a soft cloth to clean the writing surface.



Assistance Required

## Parts List

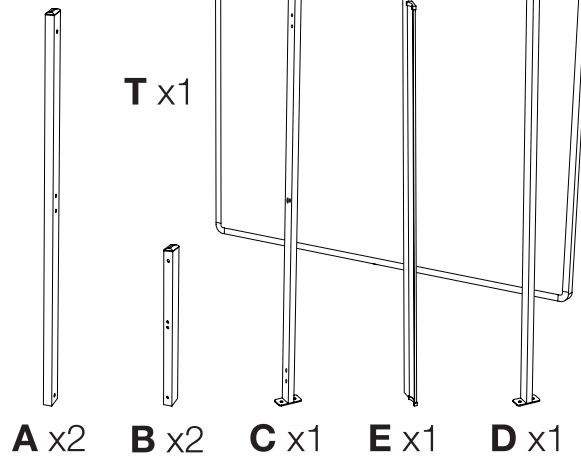

## Tools Required

- Additional Wrench

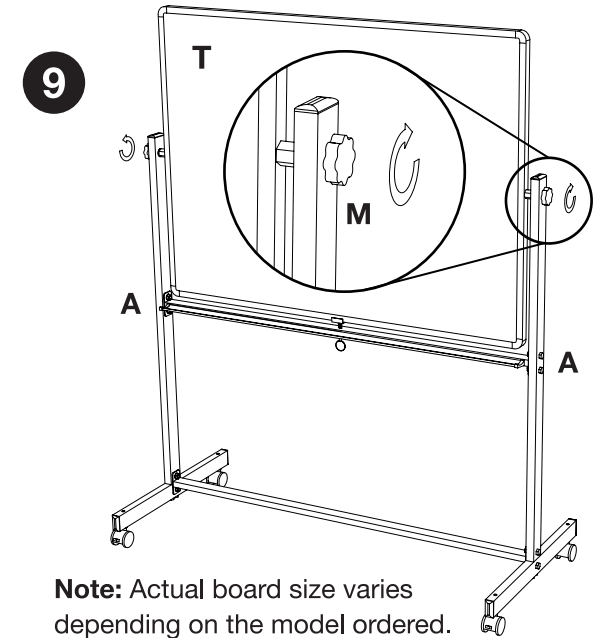
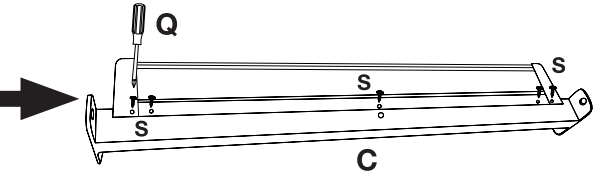
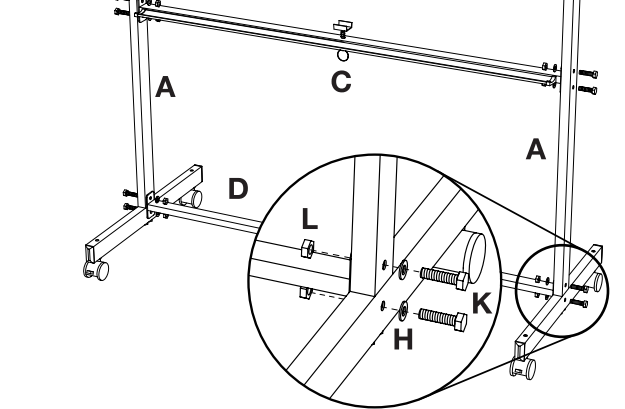
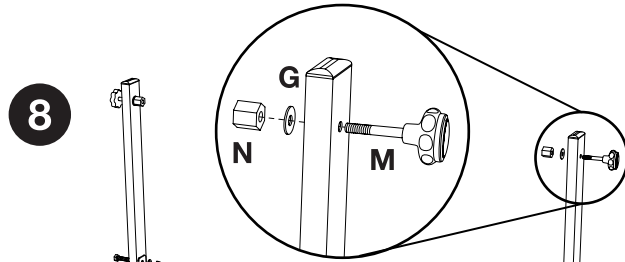
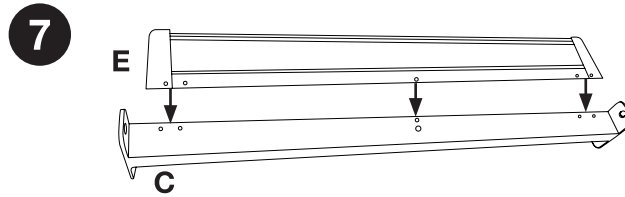
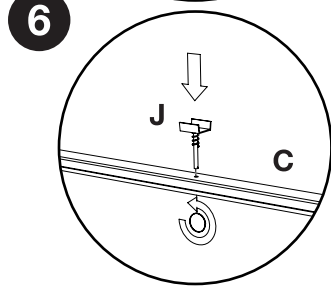
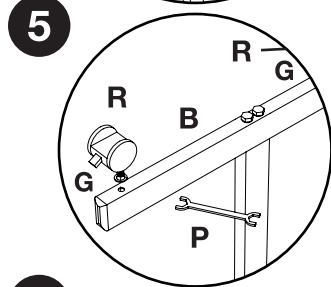
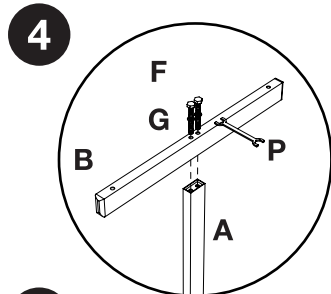
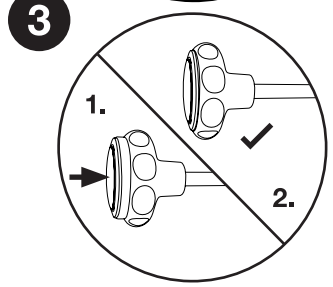
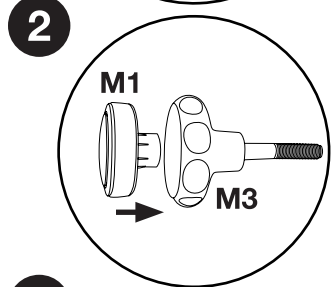
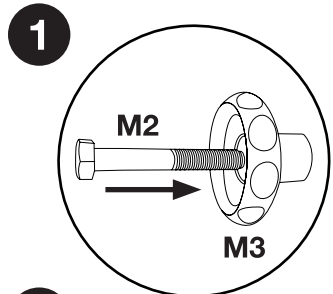
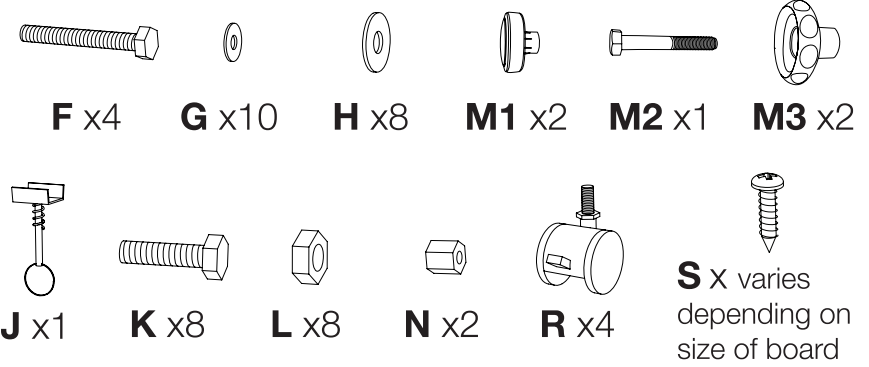
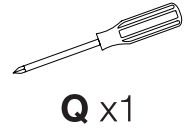
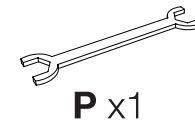

**Note:** Actual board size varies depending on the model ordered.