

LUXOR WORKSPACES

www.luxorworkspaces.com
800-323-4656

LLMCWP Modular Charging Cabinet - Wall Mount Bracket Assembly Instructions

Parts Key

A x1

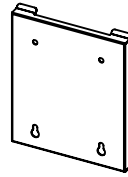

Wall Plate

B x4

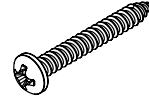

Screw,
Phillips Head

C x4



Flat
Washer

D x4

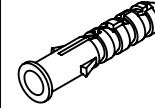

Drywall
Mounts

E x4



Bolt,
Phillips Head

Tools Required:
Phillips Head
Screwdriver



Drill

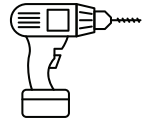

- 1** Hold mounting plate in desired position on the wall, mark the center of the four mounting holes.

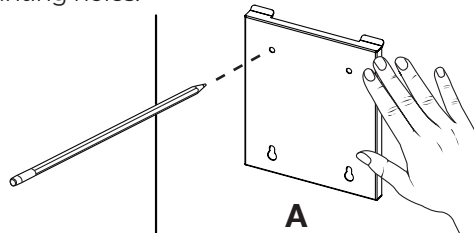

- 2** Pre drill holes in wall and insert drywall mounts.

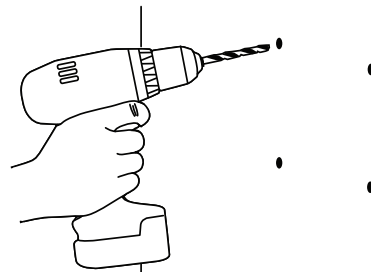

- 3** Once drywall mounts have been inserted, attach the mounting plate to the wall using four washers and four screws.

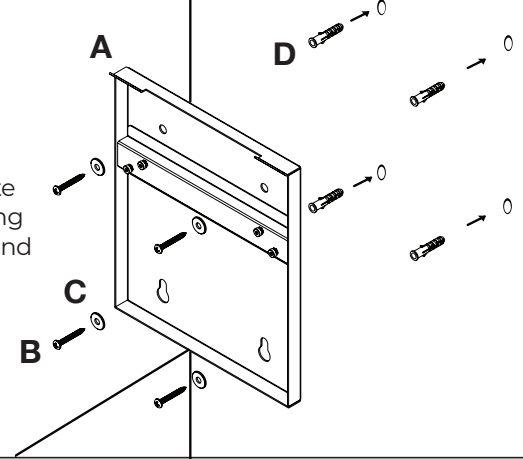

- 4** Tilt cabinet and hang onto mounting bracket.

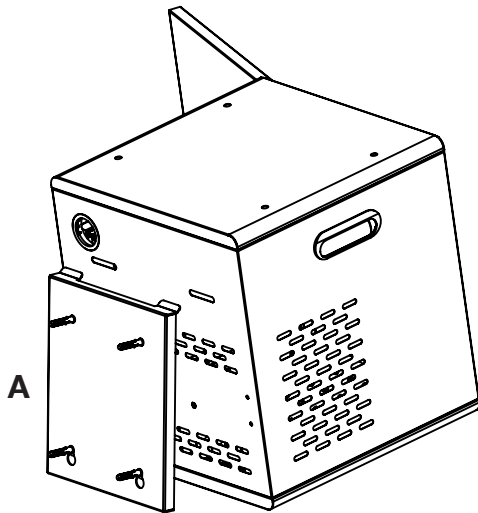

- 5** Secure cabinet to mounting bracket from the inside of the cabinet using four screws.

