

35314

ShredMATIC®

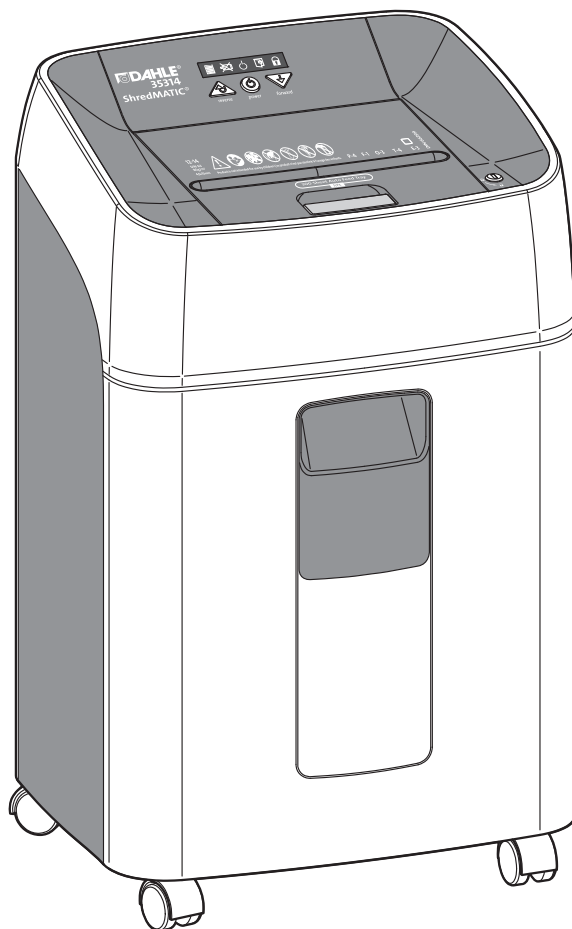

CE

DAHLE®



en Instructions



IMPORTANT!

Read the operating and safety instructions BEFORE placing the document shredder into operation.

You must follow the instructions. Keep the operating instructions in a safe place ready for later use.

Table of Contents

1	Important information	7
1.1	Intended use, warranty	7
1.2	Safety instructions	8
1.3	Key to pictograms	9
1.4	Scope of supply	62
1.5	Technical specifications	62
2	Operation	63
2.2	Connecting the device to the main supply	63
2.3	Switch on the device	63
2.4	Paper shredding	64
2.10	Continuous operation	66
2.11	Locking	67
2.14	CD, DVD & card shredding	68
3	Maintenance / troubleshooting	70
3.1	Emptying shredding waste	70
3.3	bin/lid open	70
3.4	Overheated	71
3.5	Paper jam manual feed	71
3.7	Paper jam automatic feed	72
3.10	Paper jam locked automatic feed	73
3.13	Emergency release	74
3.17	Cleaning the shredder	75

1.1 Intended use, warranty

The document shredder is intended to be used for shredding paper. Depending on the model variant, a small amount of the following materials can also be shredded:

- CDs/DVDs, bank cards and credit cards (see technical data).
- The normal staples and paper clips found in paper documents (exception: security level P6 and P7 devices).

This device is equipped with an automatic feeder for paper stacks consisting of unfolded single sheets (max. 100g/m²). Stapled paper, with paper clips as well as with staples, usually can be processed as well. Therefore it is mandatory, that the clamps and paper clips must be positioned at the rear end of the paper tray (facing away from the user)

To extend the life of the device, it is however recommended to remove paper clips/clamps before shredding. In individual cases, depending on the quantity and position of the paper clips/staples and the thickness of the stapled paper stack, a misfeed can occur and the shredding process may be interrupted

Wear, damage due to improper use or unauthorised modifications and repairs are not covered by the warranty or the guarantee.

The document shredder was designed for private use and for use in normal office environments.

The following conditions apply to the performance in terms of sheets listed under technical data:

Maximum number of sheets that are shredded in one pass under the following conditions: New cutting rollers, oiled if needed, cold motor, power supply with



nominal voltage and nominal frequency (230 V/50 Hz; 120 V/60 Hz). Deviations may result in reduced sheet processing and increased operating noises. The sheets are fed centrally and lengthwise at a 90 degree angle. The performance in terms of sheets can also vary depending on the paper properties and input.

1.2 Safety instructions

- Do not place the device near a source of heat.
- Store, transport and operate the device in an upright position only.
- Only use liquids and gases on the device that comply with DAHLE guidelines.
- Do not open up the device.
- Only operate the device in closed spaces, at temperatures of between 10 °C and 25 °C (50 °F to 77 °F) and at a non-condensing humidity of between 15% and 95%.
- Ensure that the building installation has short-circuit protection: max. 16 A (US max. 20 A).
- Do not operate the document shredder without inserting documents.
- The device is not intended for use by persons (including children) with restricted physical, sensory or mental capabilities or a lack of experience and knowledge, unless they are working under supervision or receive detailed instruction about how to use the device from a person who is responsible for safety.



Dispose of the document shredder properly in an environmentally friendly way at an authorised collection point. Do not dispose of any parts of the document shredder or packaging in domestic waste.



1.3 Key to pictograms



Important information



User information/safety instructions



WARNING



Do not use near caustic substances.



Place the device in a stable position on the floor, leaving a gap of 100 mm to the wall, ensure no heat can accumulate, engage brake mechanisms (depending on type)



Do not use near inflammable liquids or gases.



Automatic start-up



Do not expose to moisture



This document shredder is not intended to be used by children (the product is not a toy).



Do not touch the paper feed with your hands.



Do not allow items of clothing to come into contact with the paper feed.



Do not allow your hair to come into contact with the paper feed.



Keep spray cans away from the device.



Remove paper clips and staples before shredding.



Do not insert any diskettes.



Always wear safety goggles when destroying CDs/DVDs!



Disconnect the document shredder from the electrical power supply before performing maintenance work.



Technical specifications - Subject to technical modifications.



Noise level when operated without shredding documents



Intake speed



Shredded paper particles



Shredded CD/DVD particles



Shredded card particles



Weight



The power plug is used to disconnect the power supply.



The mains socket must be easily accessible at all times.



How to use



Document shredder on standby



Document shredder in operation



Automatic shut-down!



The document shredder will switch off automatically to cool down if used for a long time and /or if overloaded



Maintenance instructions / troubleshooting



Container full



Possible malfunctions



Automatic switch-off when housing is open

1.4

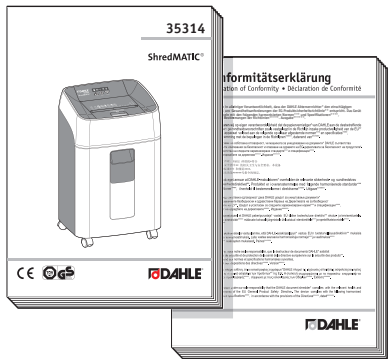
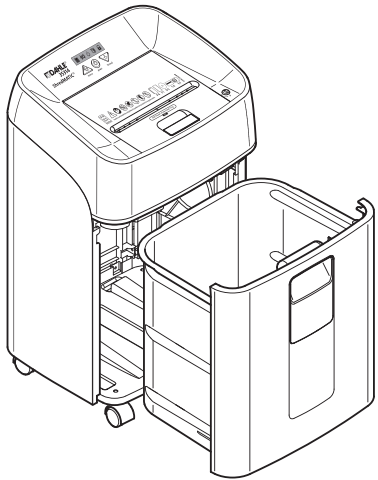

1.5

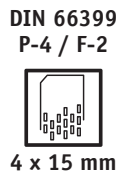
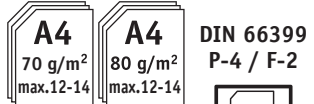
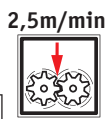
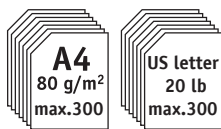

220 - 240 V / 50 - 60 Hz
110 - 120 V / 50 - 60 Hz

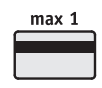
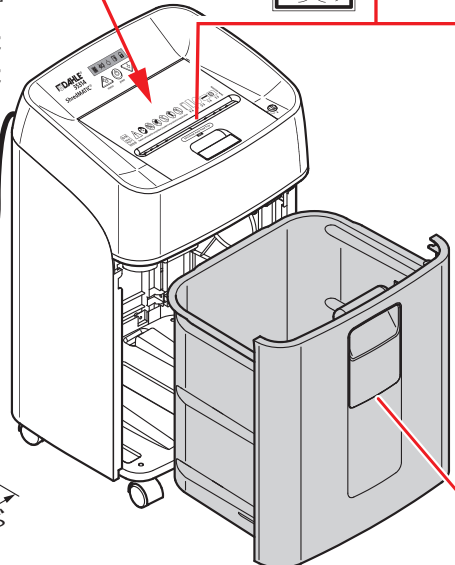
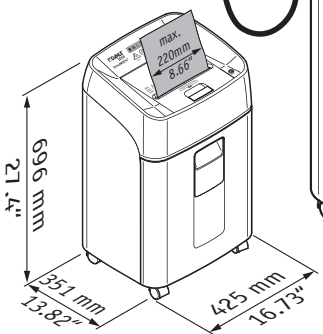

2



2.1



2.2

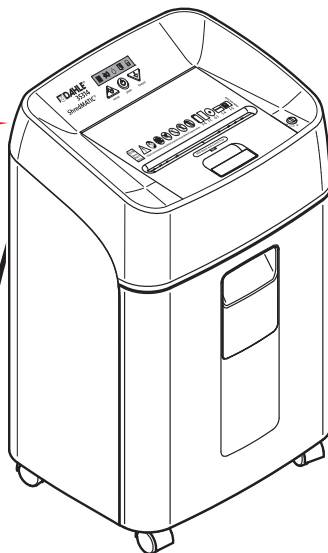
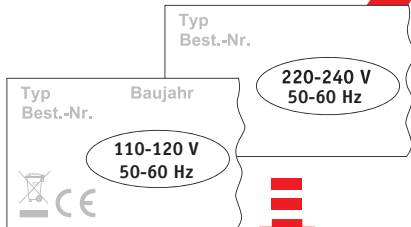

2.3

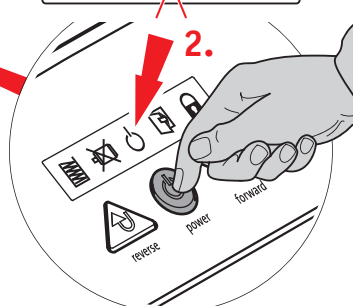
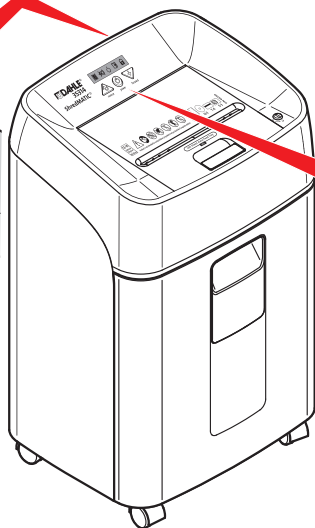
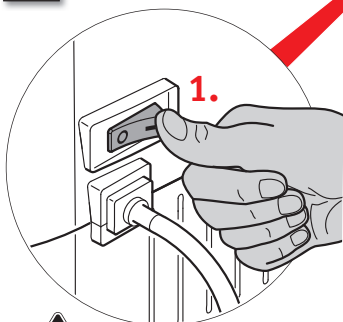

2



2.4



2.5

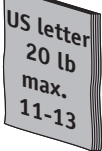
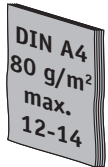
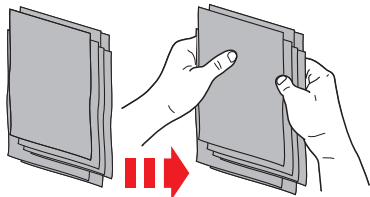

O.K.

O.K.

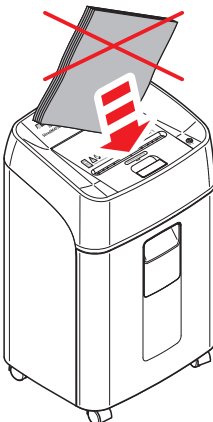
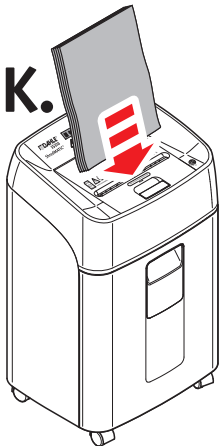

2.6

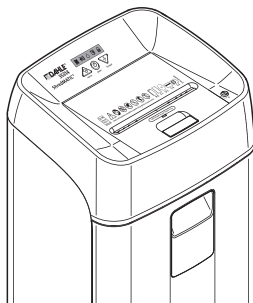
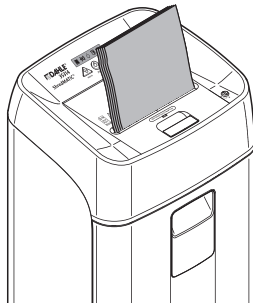
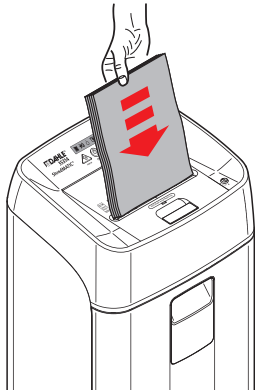

2



2.7

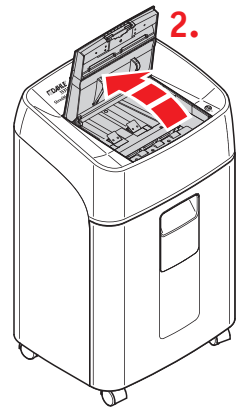
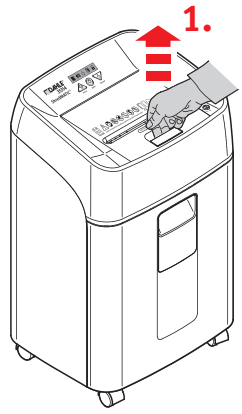

O.K.

2.8

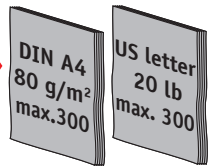
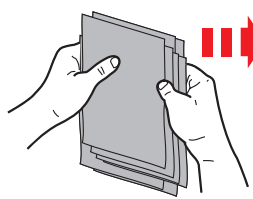

O.K.

O.K.

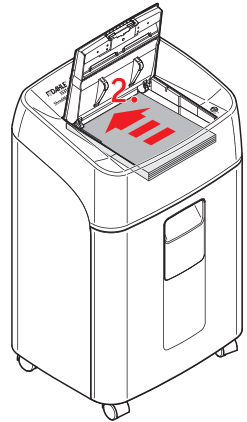
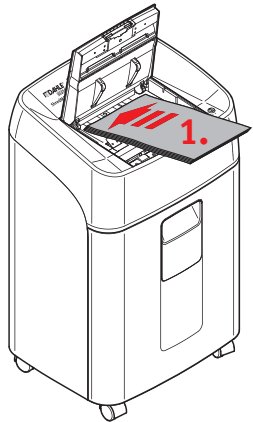

2.9

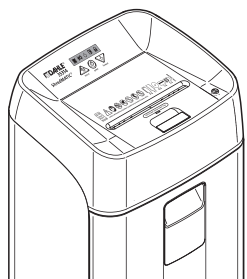
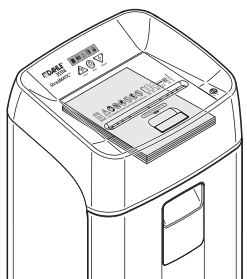
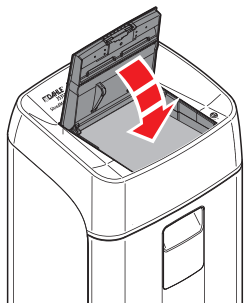



2.10

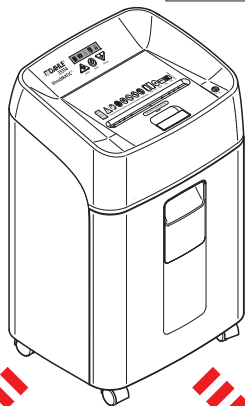
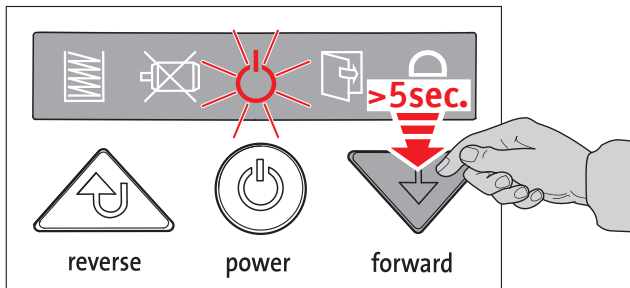

5min

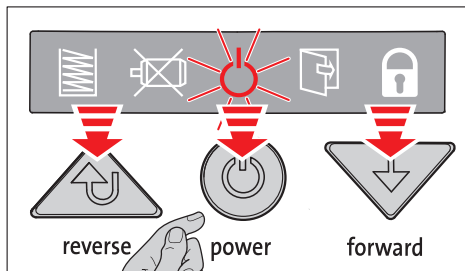



2.11

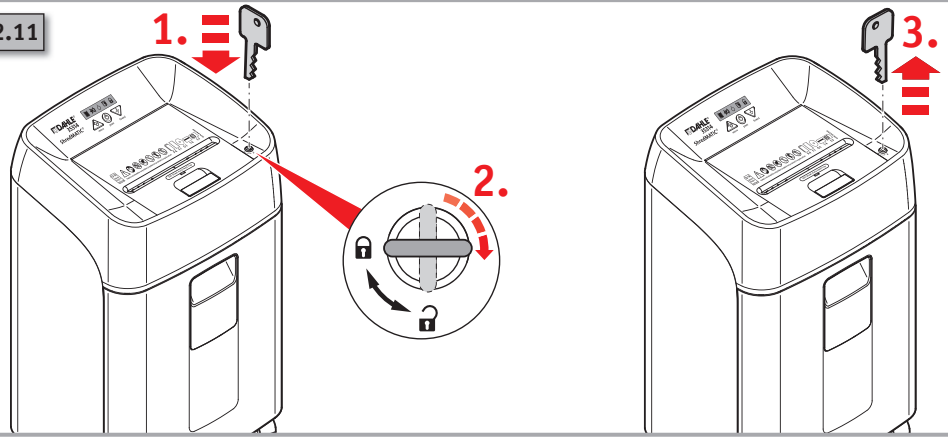

2.12

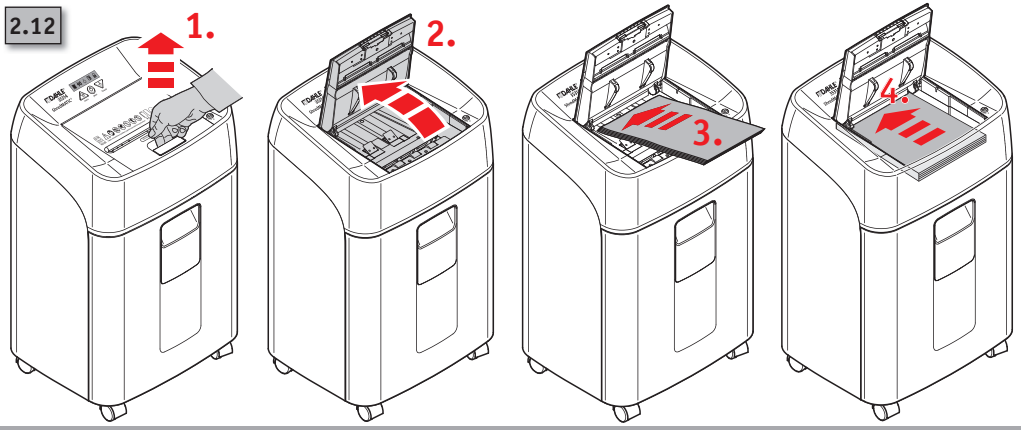

2.13

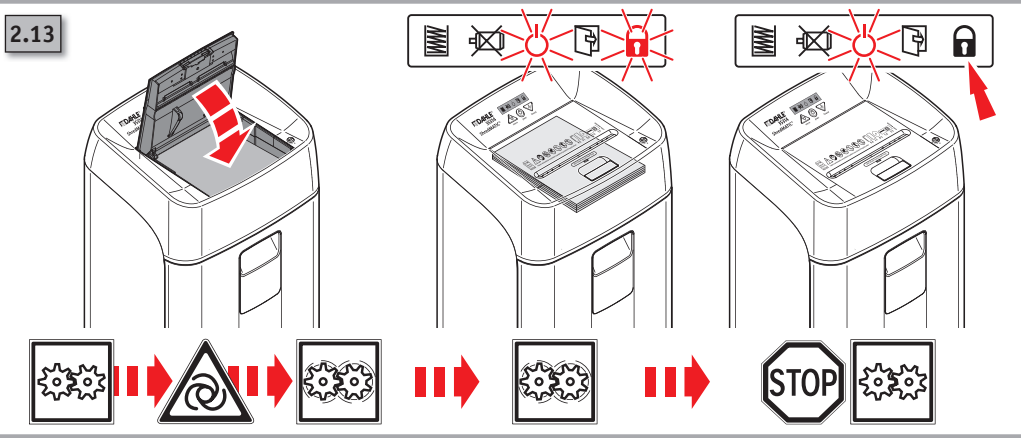

2



2.14



2.15

O.K.

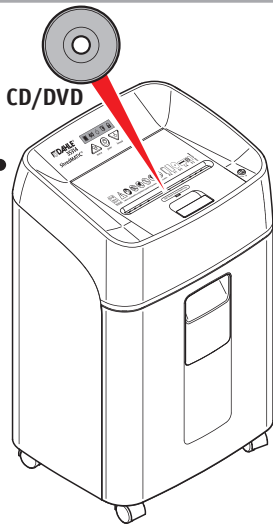

O.K.

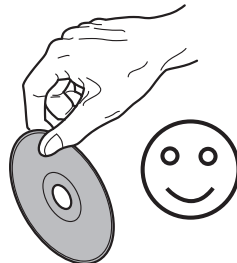

~~O.K.~~

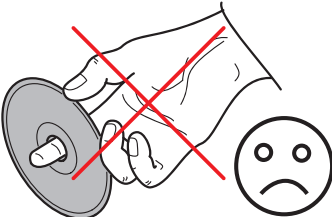

2.16

max. 1

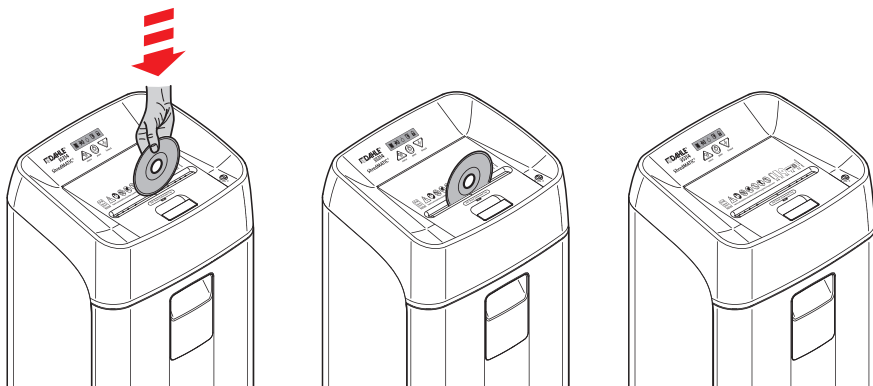



2.17

Credit card max. 1

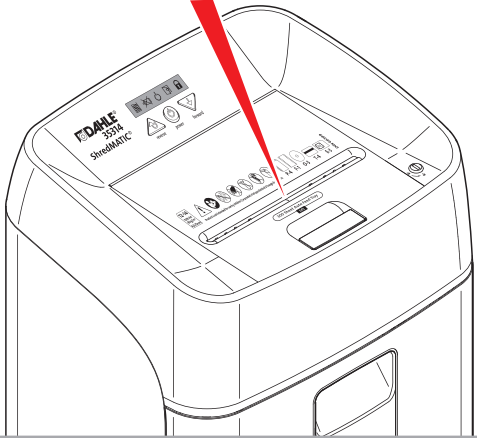

O.K.

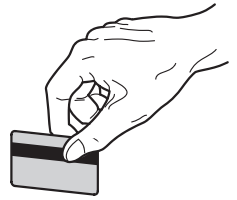

~~O.K.~~

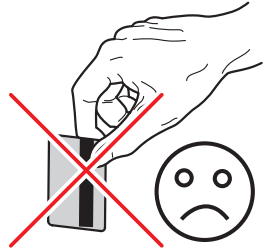

2.18

max. 1

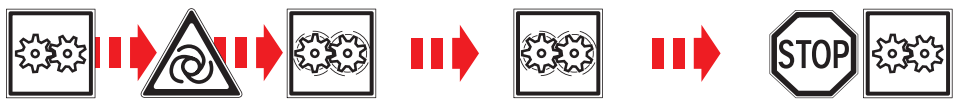
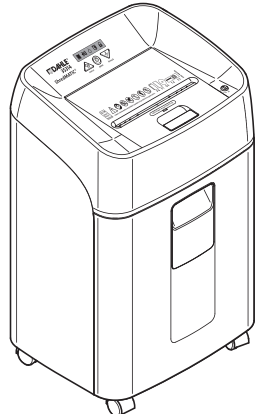
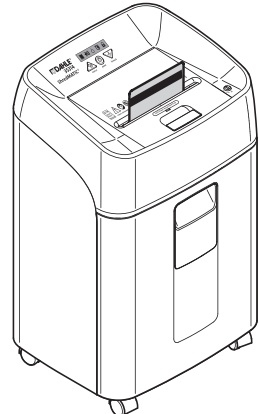
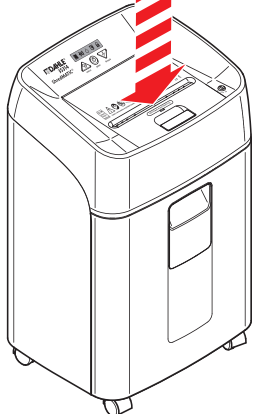

3



3.1



~~O.K.~~

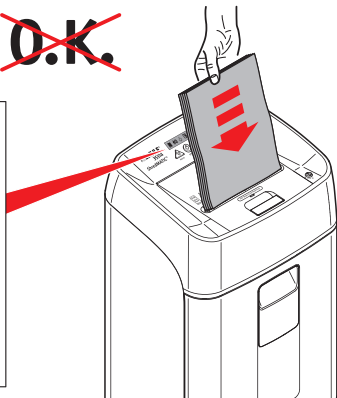
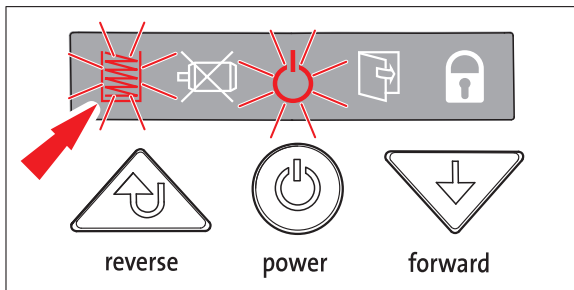

3.2



1.

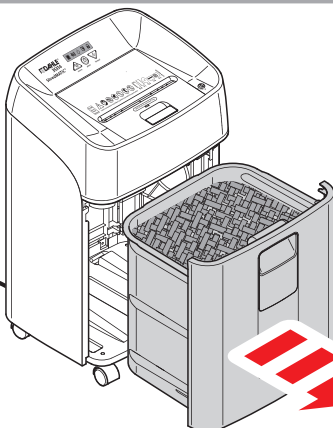

3.

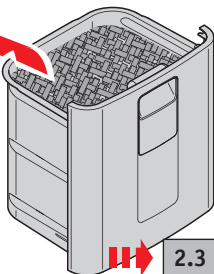

2.3

3.3

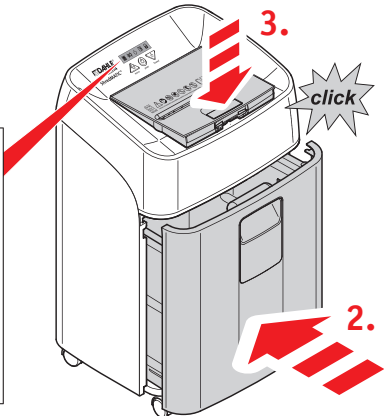
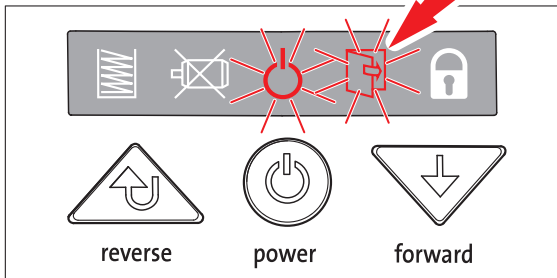



3.4

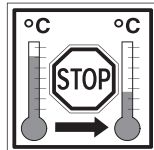

2.5

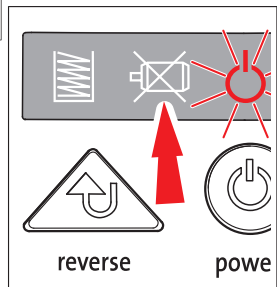
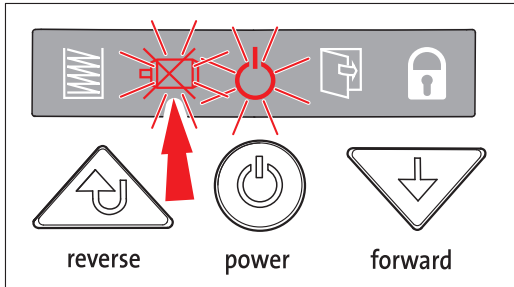

3.5

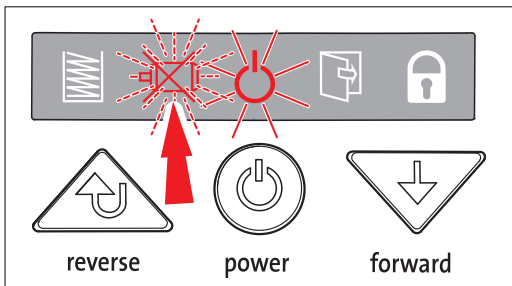

3.6

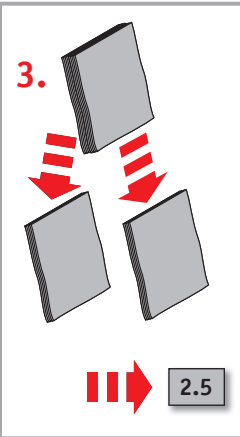
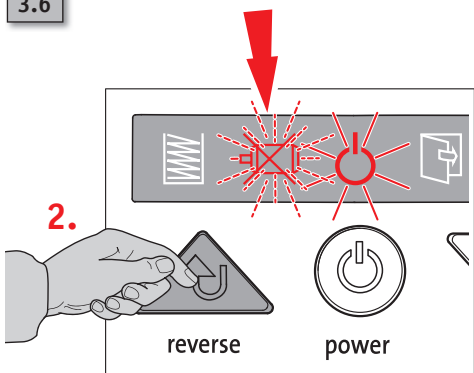

3



3.7



~~O.K.~~

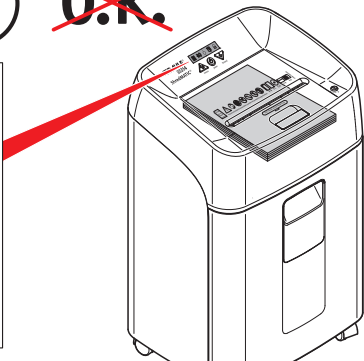
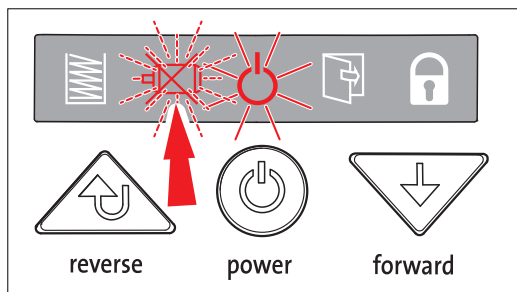

3.8

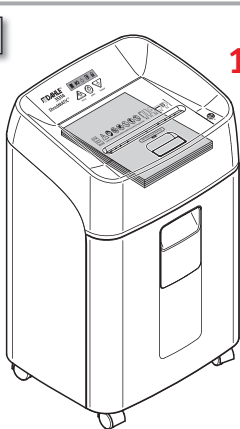

1.

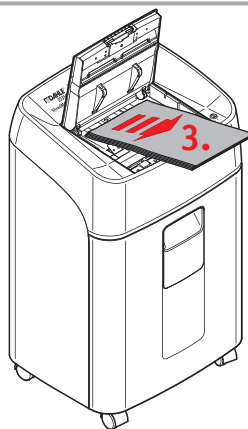
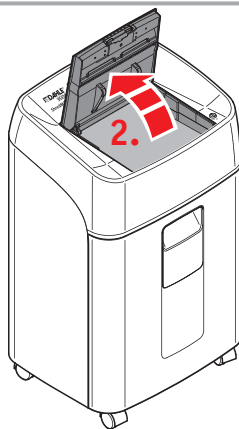

3.9

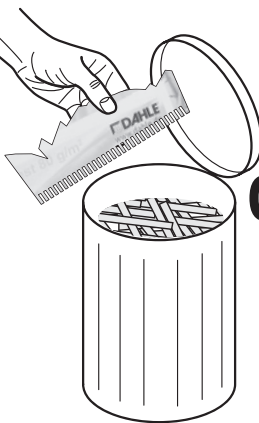
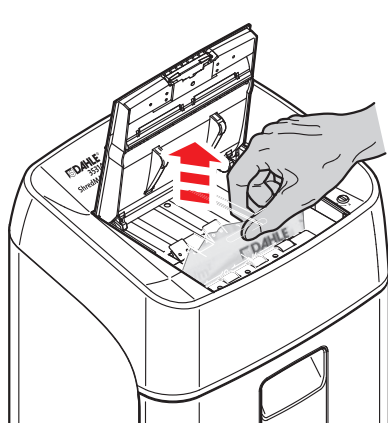

O.K.



3.10



~~O.K.~~

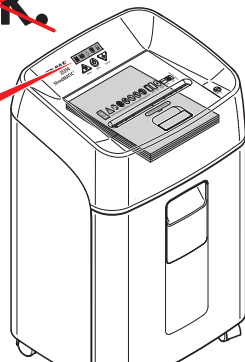
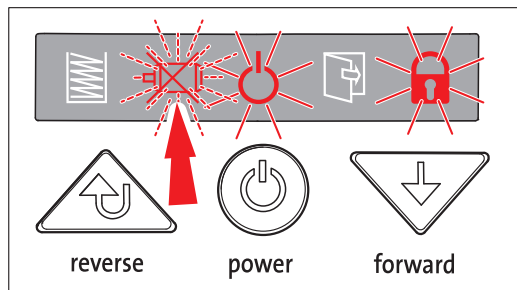

3.11

1.

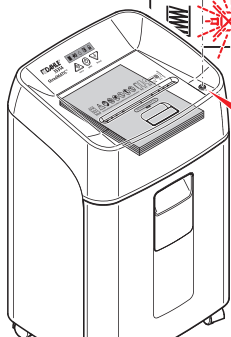
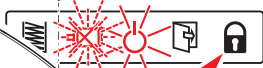

4.

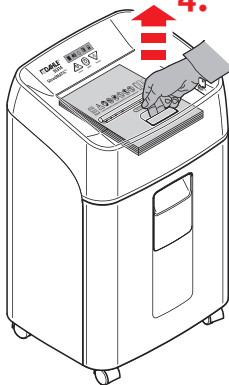

5.

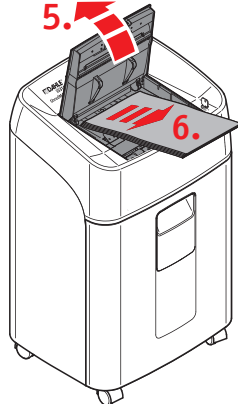

6.

3.12

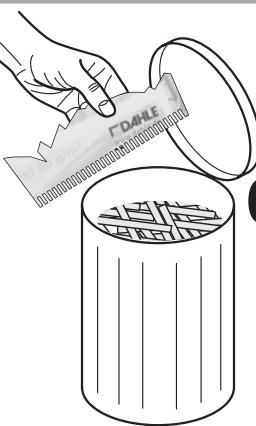
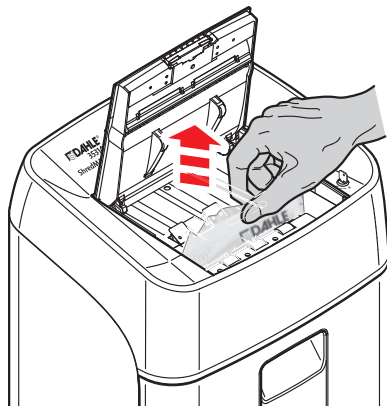

O.K.

2



3.13



~~O.K.~~

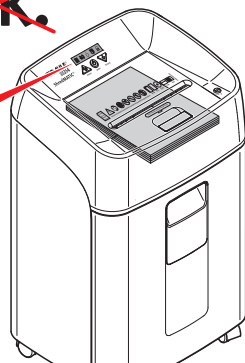
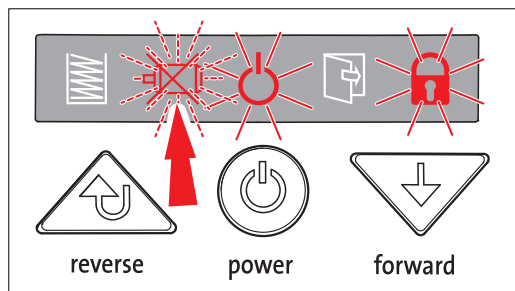

3.14

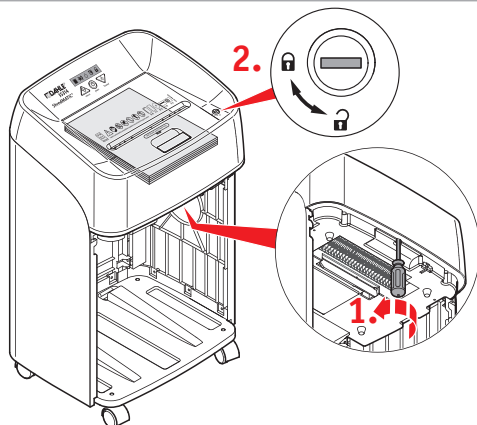
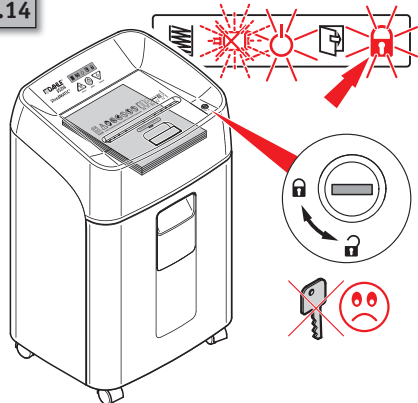

3.15

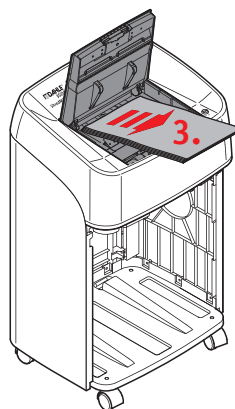
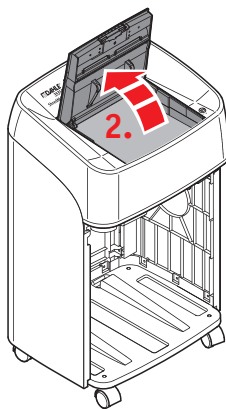
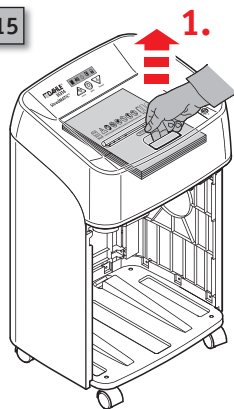

3



3.16

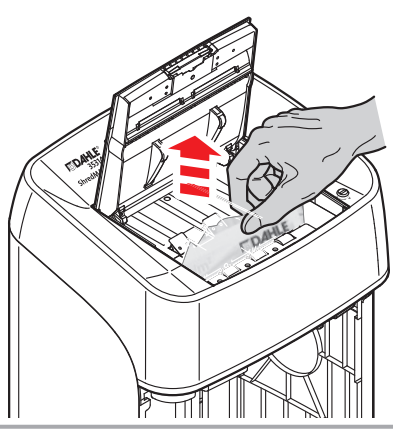

O.K.

3.17



1.

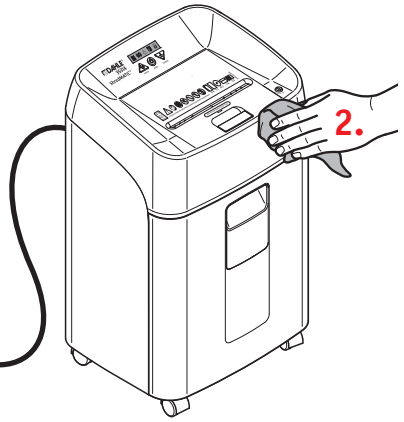

3.18



1.

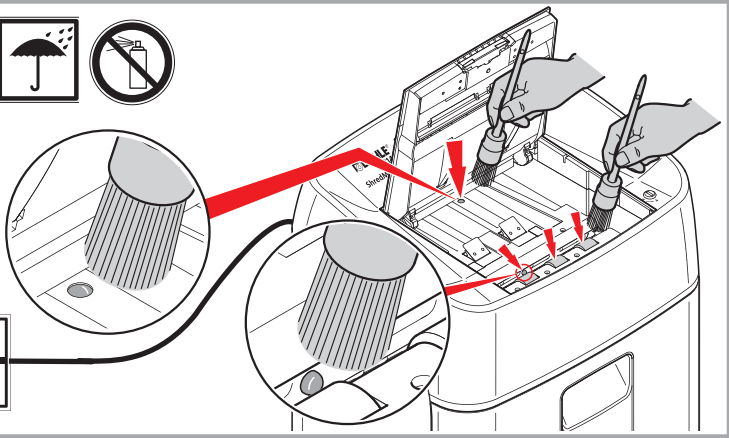

Headquarters:

Novus Dahle GmbH
Breslauer Straße 34-38
49808 Lingen (Ems) / Germany

Service contact:

Novus Dahle GmbH
Nikolaus-A.-Otto-Straße 11
96472 Rödental / Germany
Tel.: +49 (0) 9563 75299-0
Fax: +49 (0) 9563 75299-333
E-Mail: info@novus-dahle.com
Web: www.novus-dahle.com