

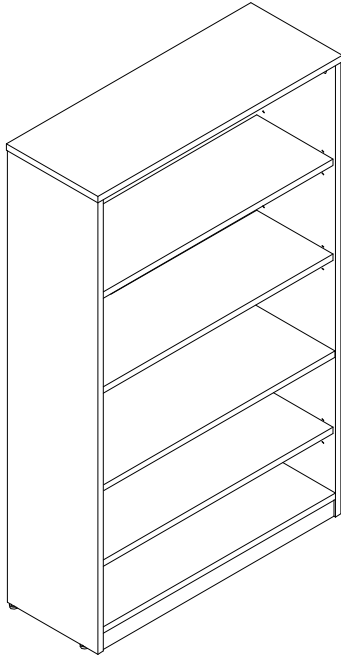

36" x 12" x 72" 5-SHELF BOOKCASE

OPERATING INSTRUCTIONS



CARE & CLEANING

Congratulations on selecting long-lasting, commercial-quality laminate furnishings for your office. All materials are carefully selected for optimum performance and built to enhance the beauty of your workplace. When assembling, always lay components on a clean, soft-cushioned surface. All surfaces can be cleaned with a solution of 9 parts water and 1 part rubbing alcohol or a non-abrasive surface cleaner. Always use a clean, soft cloth.

WARNING

1. Use this product for its intended purpose.
2. Do not sit or stand on this product.
3. Do not use unless all fasteners are secured. At least every six months, check all connections to ensure they are tight.
4. All pedestals with drawers must be secured in position.
5. Open only one drawer at a time on any unit with drawers.
6. Do not modify this product in any way.
7. If any parts are missing, broken, damaged or worn, stop use of the product until repairs are made using factory authorized parts.
8. Dispose of packing material properly.
9. Failure to follow these warnings could result in serious injury.

LIMITED WARRANTY

OSP Furniture is warranted from the original purchase date to the original purchaser for normal commercial usage – defined as a standard forty-hour work week – according to the below-listed schedule and limitations.

- 10 years against failure due to materials and workmanship
- Laminate finishes are covered for a period of 5 years
- Veneer finishes are covered for a period of 3 years
- Electrical components are not covered by this warranty

Grain, color and finishes

Variation of grain and color are natural, inherent characteristics of wood, a living material. This variation is part of the beauty of real wood and anticipated in wood veneer furniture. Therefore, OSP Furniture is not warranted to match in grain or color or texture. It is a natural phenomenon for wood grain to change in color as it ages, and wood finishes are not warranted for color-fastness.

Exclusions

This warranty will not cover labor, freight or damage from misuse, abuse, negligence, alteration, assembly, installation, attachments, accident, vandalism, acts of nature or any other event beyond the control of Office Star Products. The warranty does not cover cosmetic damage that may result from normal use. Liability for incidental or consequential damage is excluded. The user assumes all risk of injury resulting from use of this product. This warranty applies only to products purchased through authorized OSP Furniture dealers and products sold within the United States of America and the Commonwealth of Canada. This warranty does not apply to products used for rental purposes. This warranty gives you specific legal rights, and you may also have other rights which vary from state to state.

Claims

To make a warranty claim, contact parts@officestar.net with the following:

- Model number
- Description of problem
- Digital images
- Original OSP invoice number or customer purchase order number

At its option, Office Star Products will:

- a) Supply compatible components of current manufacture
- b) Repair the customer's component. The customer must prepay freight on any components returned to the factory. Return freight on components still in warranty will be paid by Office Star Products.

Contacts

The Parts Department will do everything possible to promptly review and remedy any problem. If you cannot contact us via email at parts@officestar.net, either fax 1-909-930-5349 or call toll-free 1-800-950-7262, Monday through Friday 8:00am to 5:00pm Pacific Time.







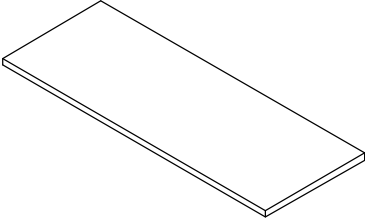
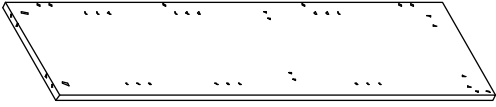
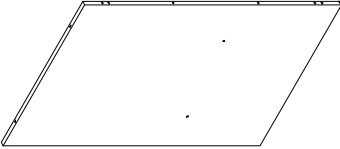
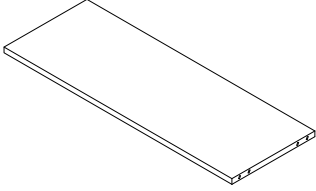
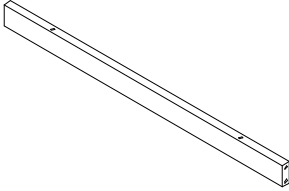
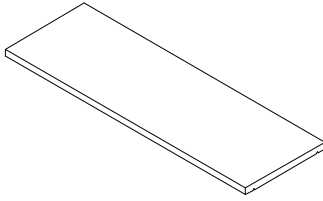
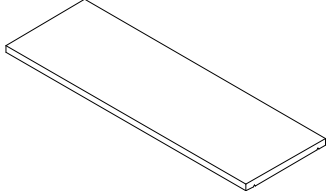

36" x 12" x 72" 5-SHELF BOOKCASE

ASSEMBLY INSTRUCTIONS

LBC361272 Consists of:

A - Top (1 pc)	B - End Panel (2 pcs)
	
C - Back Panel (1 pc)	D - Bottom Shelf (1 pc)
	
E - Bottom Rail (1 pc)	F - Adjustable Shelf (3 pcs)
	
G - Fixed Shelf (1 pc)	
	

No.	Drawing	Description	Qty.	No.	Drawing	Description	Qty.
H		Cam Lock	26 pcs +1 extra	K		Leveler	4 pcs
I		Cam Pin	26 pcs	L		Shelf Pin	12 pcs
J		Dowel	21 pcs	M		Cam Cover	4 pcs

STEP 1

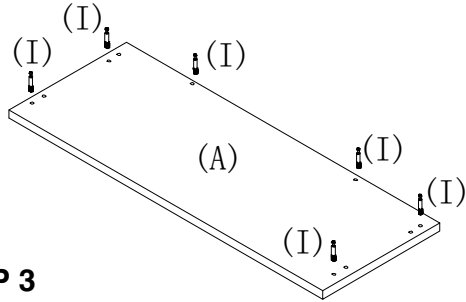

STEP 2

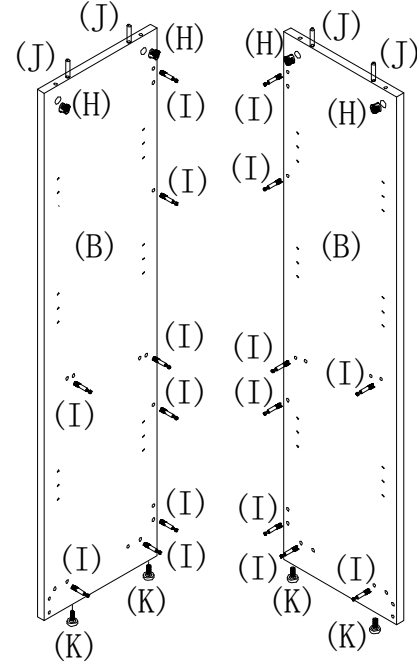

STEP 3

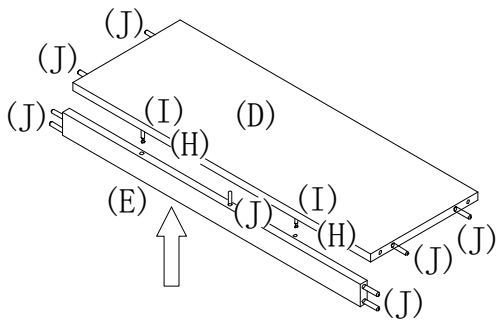

STEP 4

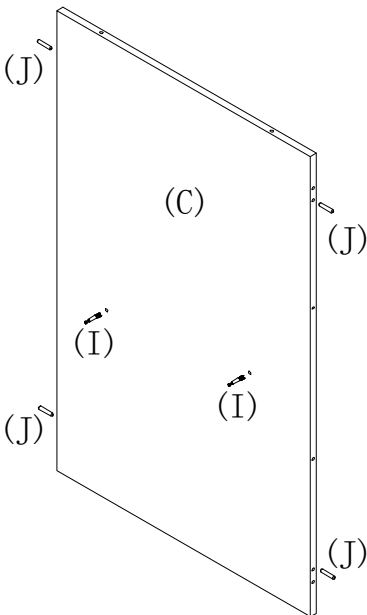

STEP 5

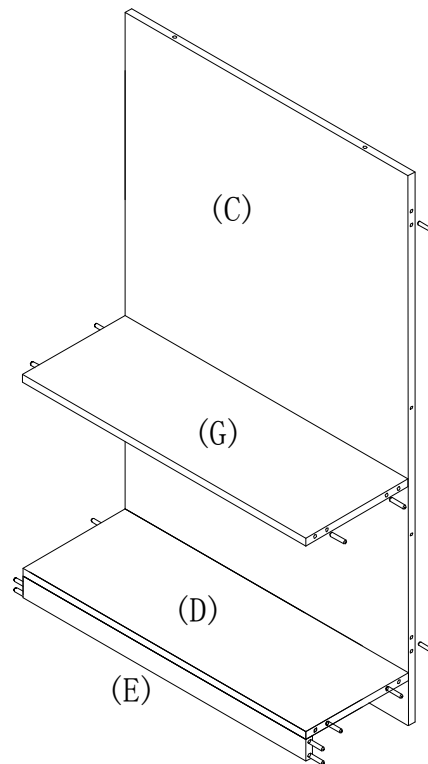

STEP 6

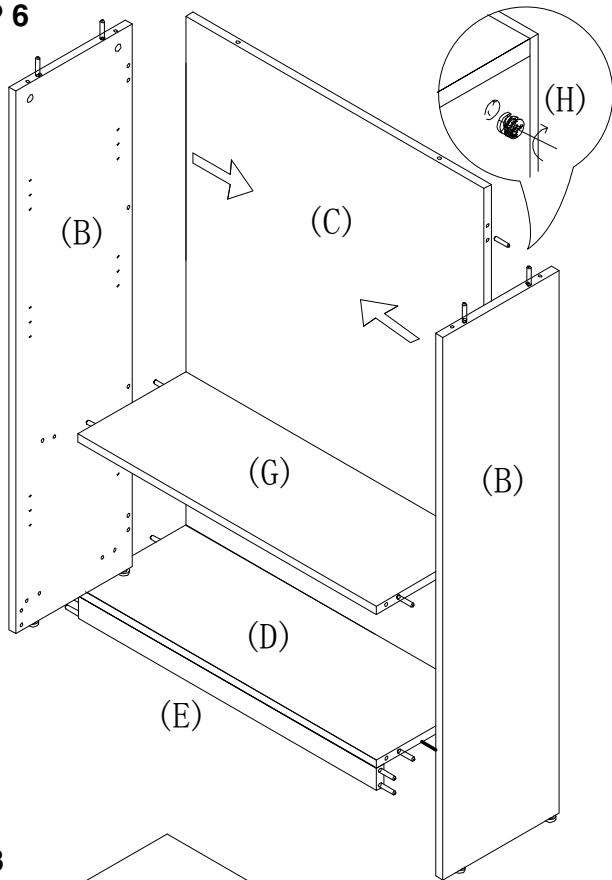

STEP 7

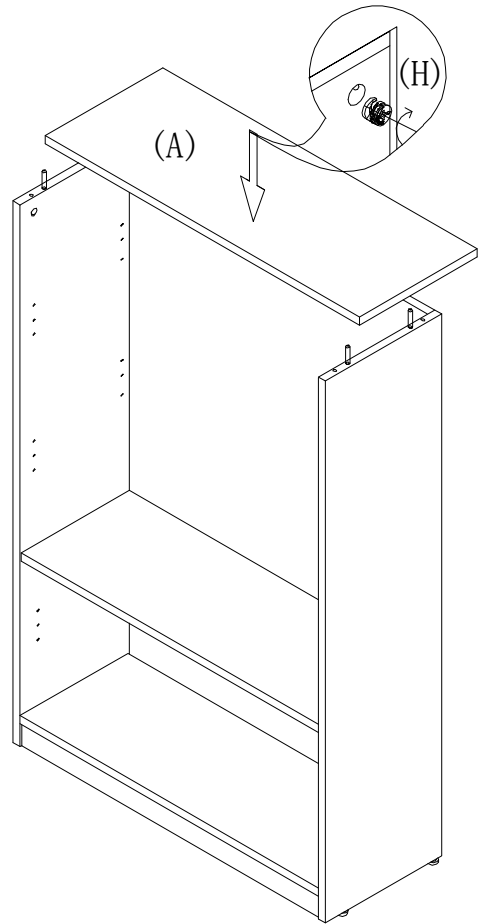

STEP 8

