

ASSEMBLY INSTRUCTIONS  
THESIS FLEX SERIES  
FLEX BACK

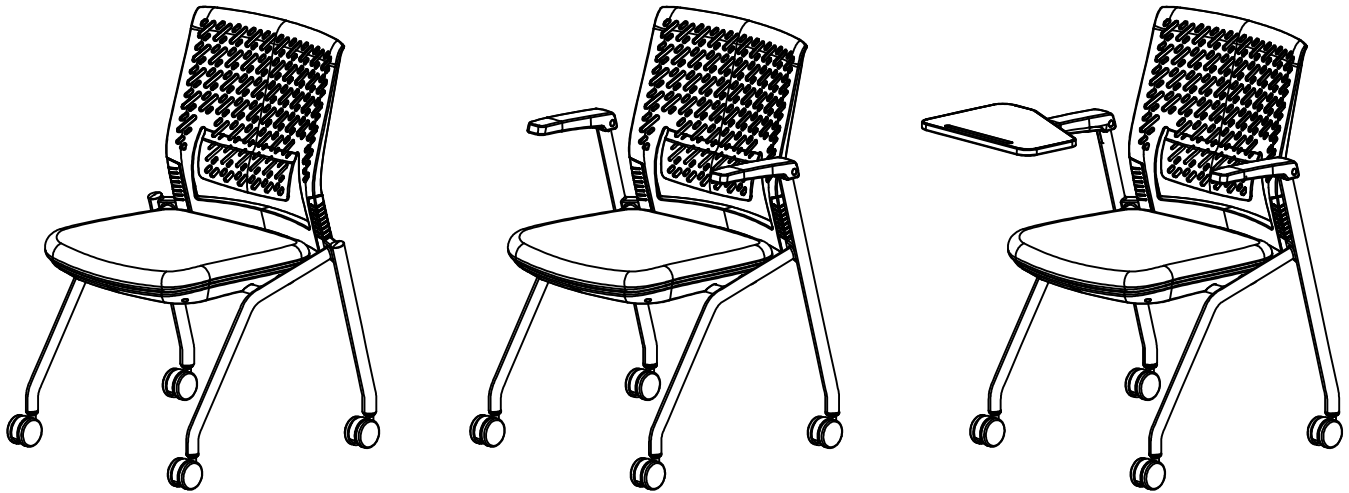

**IMPORTANT!**

**Review ALL instructions before beginning assembly.** These instructions are provided to avoid problems that may occur from improper assembly or installation. Mayline and/or its distributor are not responsible for failure resulting from improper assembly or installation of this product. Moreover, all warranties are void for failure to follow these assembly instructions.

**MAYLINE®**

Mayline Company, LLC  
619 N. Commerce, P.O. Box 728  
Sheboygan, WI 53082-0728  
Toll Free: 1-800-822-8037  
FAX: 920-457-7388  
On Line: [www.mayline.com](http://www.mayline.com)









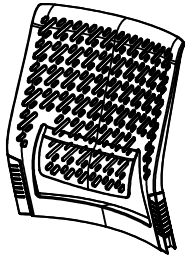

# PARTS LIST

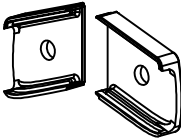
When ordering components, specific color and/or size information may be required.  
 Contact a Mayline Customer Service Representative. 1-800-822-8037

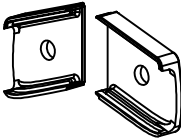
*\* Individual Items, Order by part number.*

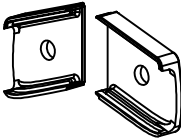
*\*\* Denotes Color Code*

*Views for reference only. Actual product may vary.*

<p>Reference Letter</p> <p style="font-size: 24pt; font-weight: bold; text-align: center;">A</p> <div style="text-align: center;">  </div> <p>Part Number <b>Back Assembly</b></p>	1	<p>Part Number <b>KNT153* Hardware Pack (Flex Back)</b></p> <table border="1" style="width: 100%; border-collapse: collapse;"> <tr> <td style="width: 30%; padding: 5px;">Reference Letter</td> <td style="width: 40%; padding: 5px;"> <div style="text-align: center;">  </div> </td> <td style="width: 30%; text-align: center; vertical-align: middle; font-size: 24pt; font-weight: bold;">2</td> </tr> <tr> <td colspan="3" style="padding: 5px;"><b>Screw M6 x 20MM</b></td> </tr> <tr> <td style="padding: 5px;">Reference Letter</td> <td style="padding: 5px;"> <div style="text-align: center;">  </div> </td> <td style="text-align: center; vertical-align: middle; font-size: 24pt; font-weight: bold;">2</td> </tr> <tr> <td colspan="3" style="padding: 5px;"><b>Back Mounting Cap, Left, Right</b></td> </tr> <tr> <td style="padding: 5px;">Reference Letter</td> <td style="padding: 5px;"> <div style="text-align: center;">  </div> </td> <td style="text-align: center; vertical-align: middle; font-size: 24pt; font-weight: bold;">1</td> </tr> <tr> <td colspan="3" style="padding: 5px;"><b>Allen Wrench</b></td> </tr> </table>	Reference Letter	<div style="text-align: center;">  </div>	2	<b>Screw M6 x 20MM</b>			Reference Letter	<div style="text-align: center;">  </div>	2	<b>Back Mounting Cap, Left, Right</b>			Reference Letter	<div style="text-align: center;">  </div>	1	<b>Allen Wrench</b>		
Reference Letter	<div style="text-align: center;">  </div>	2																		
<b>Screw M6 x 20MM</b>																				
Reference Letter	<div style="text-align: center;">  </div>	2																		
<b>Back Mounting Cap, Left, Right</b>																				
Reference Letter	<div style="text-align: center;">  </div>	1																		
<b>Allen Wrench</b>																				
<p>Reference Letter</p> <p style="font-size: 24pt; font-weight: bold; text-align: center;">B</p> <div style="text-align: center;">  </div> <p>Part Number <b>Frame/Seat Assembly</b></p>	1																			
<p>Reference Letter</p> <p style="font-size: 24pt; font-weight: bold; text-align: center;">C</p> <div style="text-align: center;">  </div> <p>KNT160 SCREW</p> <p>Part Number <b>KNT109 Tablet Assembly w/Screw</b></p>	1																			
<p>Reference Letter</p> <p style="font-size: 24pt; font-weight: bold; text-align: center;">D*</p> <div style="text-align: center;">  </div> <p>Part Number <b>KNT119 Caster (4 pack)</b></p>	1																			

1. Attach Back Assembly (A) to Frame/Seat Assembly (B) using Screw (E) & Back Mounting Cap, Left & Right. (F). 2 Places. NOTE: See "L" or "R" on Caps and arrows to be assembled outward.

2. Insert Casters (D) firmly into the Frame/Seat Assembly (B). 4 Places.

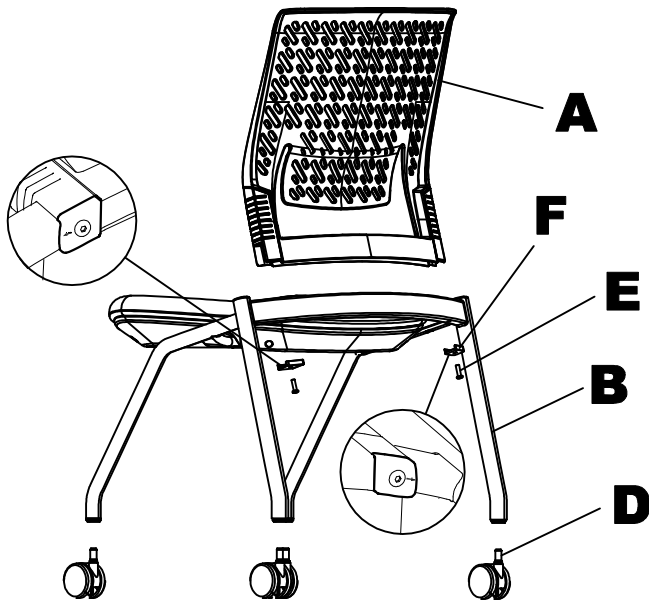

### Chairs with Tablet Assembly

3. Attach Tablet Assembly (C) to Frame/Seat Assembly (B) using Screw included with Tablet Assembly.

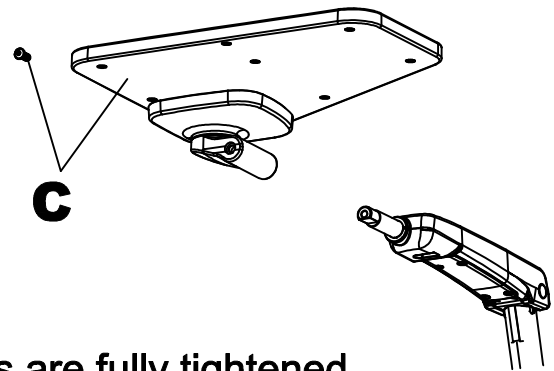

### NOTE:

Periodically (Every 90 days) make sure screws are fully tightened.

### FEATURE INSTRUCTIONS

#### 1. Seat Adjustment.

Lifts upward 92° to allow nesting & stacking.

#### 2. Arm Adjustment

Lifts upward 70° to allow nesting & stacking.

#### 3. Tablet Adjustment

Automatically rotates to side position when tablet rotates 60° forward or 90° upward.

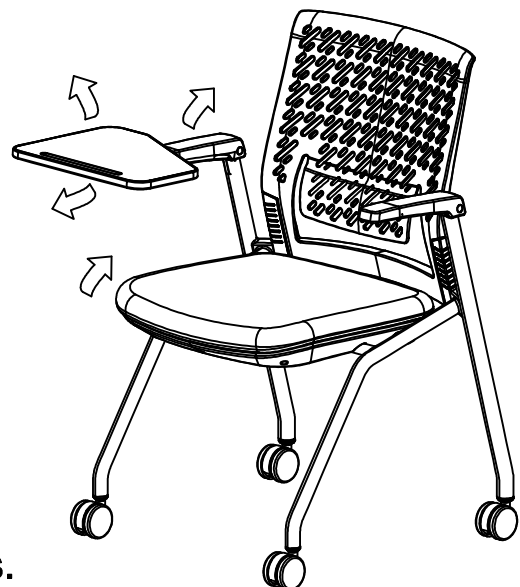

Note: Tablet maximum weight capacity 100lbs.