







Aberdeen Series™
Personal Storage Tower
Model No. APST



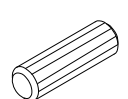

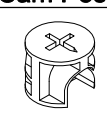

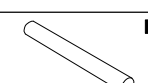

ASSEMBLY INSTRUCTIONS

CALL 1-800-822-8037 FOR ASSISTANCE

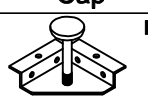
PARTS LIST

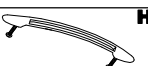







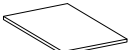

Name	Part	Qty.	Spare Qty
A	 REALS004 Wood Dowel	26	3
B	 REALS003 Cam Post	24	3
C	 REALS001 Cam Fastener	24	3
D	 REALS102** Cam Sticker	24	3
E	 REALS172 Garment Bar Support	2	
F	 REALS017 Ø4mm*16mm	4	1

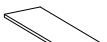
Name	Part	Qty.	Spare Qty
G	 REALS173 Garment Bar	1	
G1	 REALS230** Cap	4	
H1	 REALS008 Plate with Leveler	4	
H2	 REALS005 Ø4mm*16mm	24	2
J	 REALS009 Shelf Pin	24	3
K	 REALS191 Handle w/ Screws	2	
	 APSTHB		

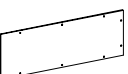
Items with HB are in hardware box.

**Denotes Color Code

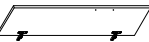
PARTS LIST

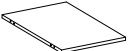
Name	Part	Qty.	Name	Part	Qty.
N	 APSTN** Top	1	V	 APSTV** Large Shelf	2
P	 APSTP** Left Side Panel	1	W	 APSTW** Small Shelf	4
Q	 APSTQ** Right Side Panel	1	X	 APSTX** Back Panel	1
R	 APSTR** Center Board	1	Y	 APSTY** Left Door	1
S	 APSTS** Bottom Panel	1	Z	 APSTZ** Right Door	1
T	 APSTT** Toe Kick	1	A1	 APST2** Drawers - Set of 2	2
U	 APSTU** Fixed Shelf	1			

**Denotes Color Code

2

- 1** Insert Dowels (A) into Toe Kick (T). Insert Dowels (A) from Toe Kick (T) into Bottom Panel (S). Install Garment Bar Support (E) to Left Side Panel (P) and Center Panel (R) using Screws (F).

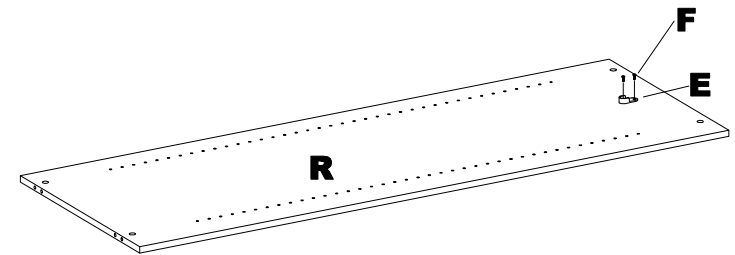
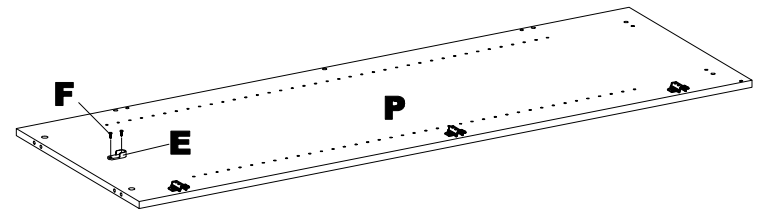
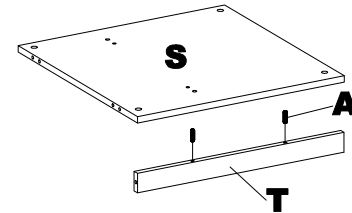

3

- 2** Install Cam Posts (B) into threaded inserts in the Bottom Panel (S). Insert Dowels (A) and Cams (C) into Center Panel (R). Position Center Panel with Grommet Bar Support (E) 'UP'. Attach the Center Panel (R) to the Bottom Panel (S) by turning Cams (C).

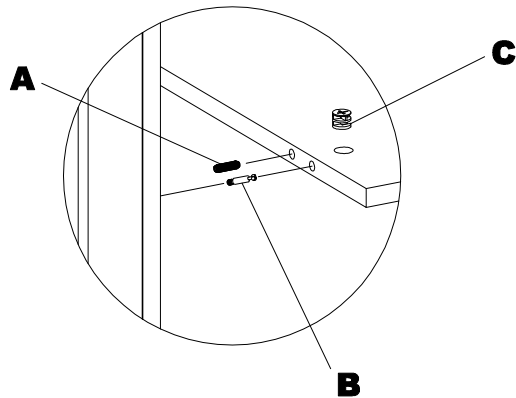
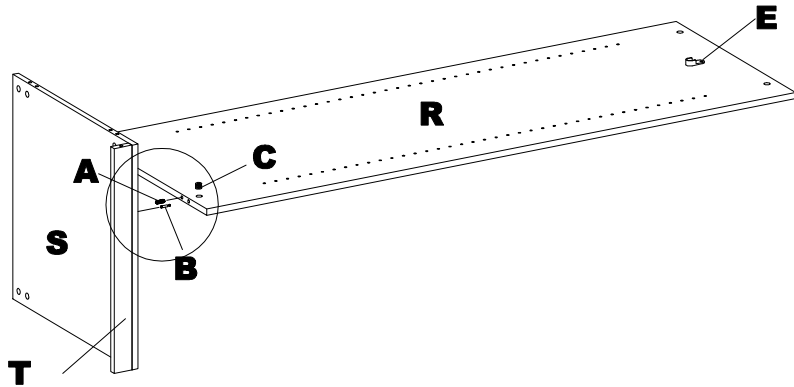

NOTE: The arrow on the face of the Cam (C) should point towards the Cam Post (B) for proper alignment.

4

- 3** Insert Dowels (A) and Cams (C) into Bottom Panel (S) and Fixed Shelf (U). Install Cam Posts (B) into threaded inserts in Right Side Panel (Q) and Center Panel (R). Attach Fixed Shelf (U) and Right Side Panel (Q) to Bottom Panel (S) and Center Panel (R) by turning Cams (C).

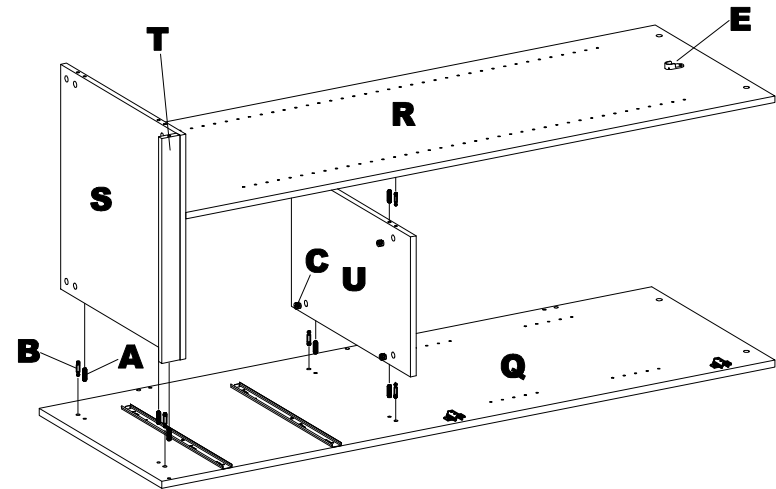

5

4

Install Cam Posts (B) into threaded inserts in Right and Left Side Panels (P, Q). Insert Dowels (A) and Cams (C) into Back Panel (X) and Bottom Panel (S). Attach Back Panel (X) and Left Side Panel (P) to Right Side Panel (Q) and Bottom Panel (S) by turning Cams (C).

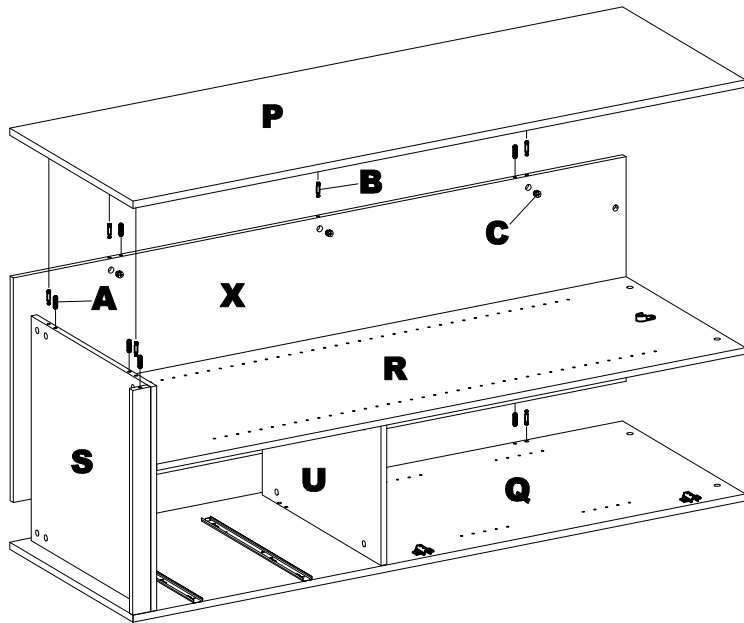
**6****5**

Install Plate with Leveler (H1) to the bottom of cabinet using Screws (H2). Insert Garment Bar (G) into Garment Bar Supports (E). Insert Dowels (A) and Cams (C) into Left and Right Side Panels (P, Q) and Back Panel (X). Install Cam Posts (C) into threaded inserts in the underside of the Top (N). Attach Top (N) to the Left and Right Side Panels (P, Q) and Back Panel (X) by turning Cams (C).

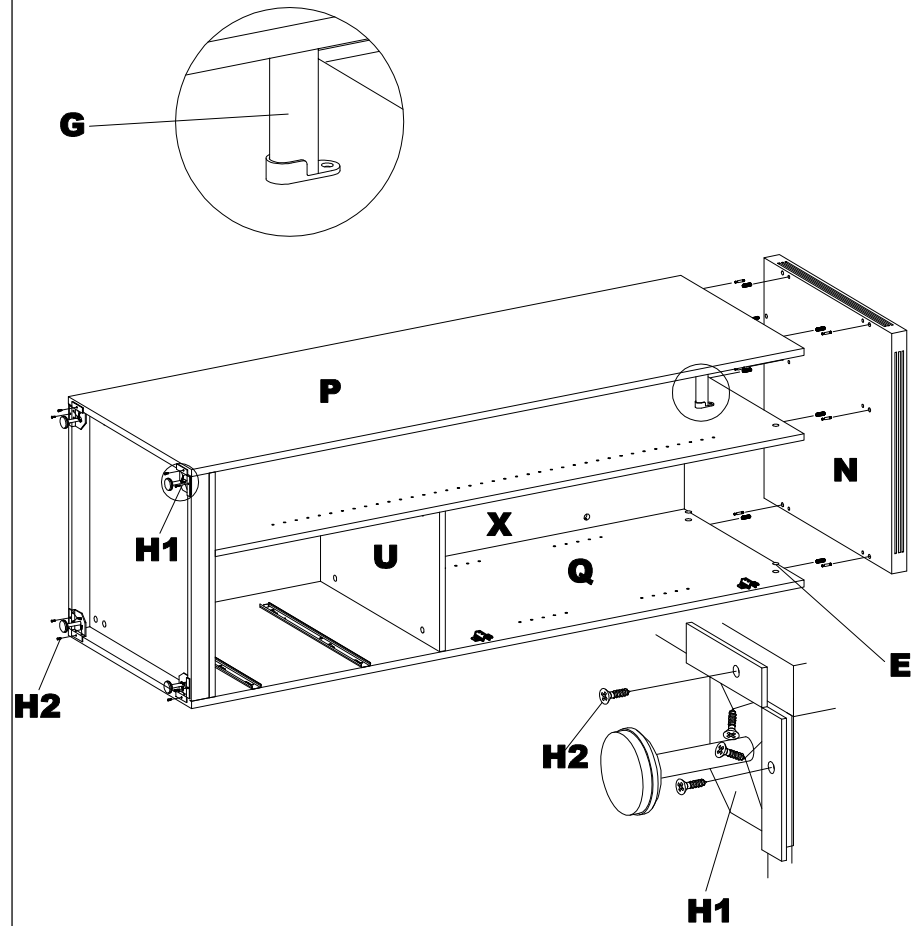
**7**

- 6** Insert Shelf Pins (J) into Left and Right Side Panels (P, Q) and Center Panel (R) in the desired position. Install Shelves (V, W) onto Shelf Pins (J).

Apply Cam Stickers (D) over exposed Cams (C). Insert Caps (G1) into adjustment holes for levelers.

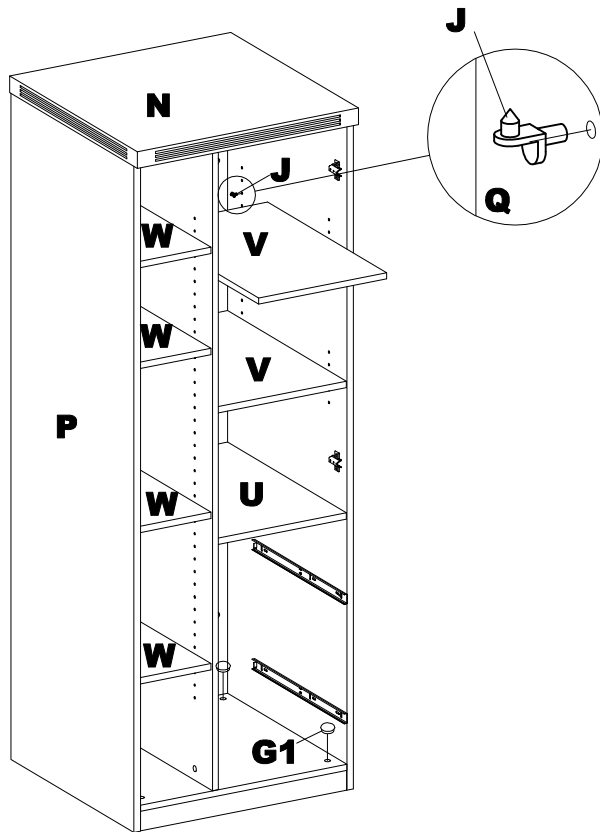

8

- 7** Attach Handles (K) to Doors (Y,Z) using screws supplied with Handle. Install Doors (Y,Z) onto cabinet.

Adjust doors for alignment as necessary by using the adjustment screws on the hinges. **DO NOT** use Power Driver to make these adjustments.

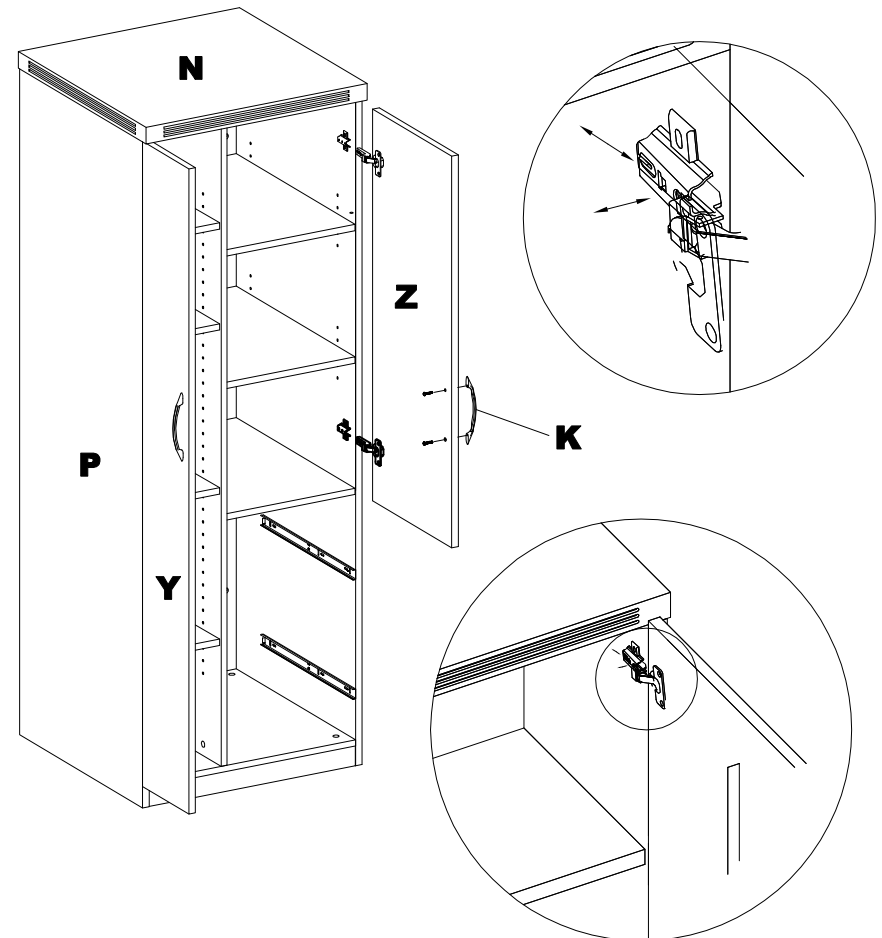

9





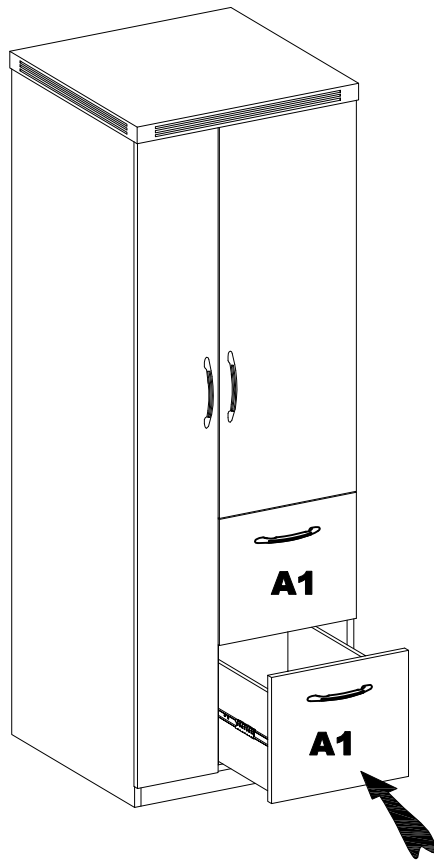

8

Install Drawers (A1) into cabinet by extending the slides in the cabinet and then aligning the grooves in the slide on the drawer with the grooves in the extended slides.



10

Pre-Installed Replacement Parts List

Part	Included Qty.	Part	Included Qty.
 REALS013 Hinge - Straight	5	 REALS013P Hinge Plate - Short	5
 REALS018 Ø4 x 14mm	20	 REALS059 18" Drawer Slide - Pair	2
 REALS191 Handle w/ Screws	2	 REALS247 Bumper	4
 REALS121 Ø3 x 14mm	32		

11