

**realoffice**

**MAYLINE**

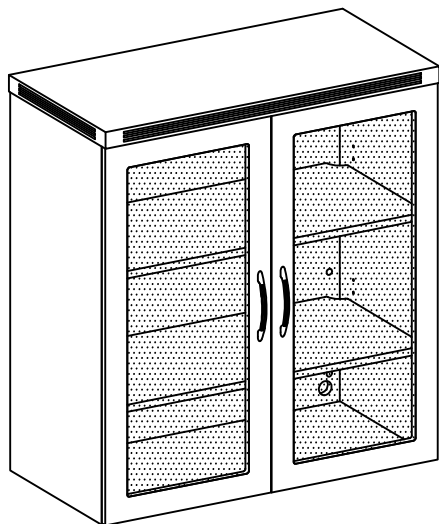







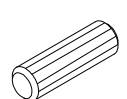

**Aberdeen Series™  
Glass Display Cabinet  
Model No. AGDC**

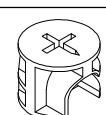

**ASSEMBLY INSTRUCTIONS**







**CALL 1-800-822-8037 FOR ASSISTANCE**

# PARTS LIST

Name	Part	Qty.	Spare Qty	Name	Part	Qty.	Spare Qty
<b>A</b>	 <b>REALS004</b> Wood Dowel	<b>16</b>	<b>2</b>	<b>G</b>	 <b>REALS104</b> Black Grommet 35mm	<b>2</b>	
<b>B</b>	 <b>REALS003</b> Cam Post	<b>18</b>	<b>2</b>	<b>H</b>	 <b>REALS204</b> Foam Tape	<b>2</b>	
<b>C</b>	 <b>REALS001</b> Cam Fastener	<b>18</b>	<b>2</b>	<b>J</b>	 <b>REALS025</b> Door Stop	<b>1</b>	
<b>D</b>	 <b>REALS102**</b> Cam Sticker	<b>18</b>	<b>2</b>	<b>K</b>	 <b>REALS017</b> Ø3.5 x 16mm	<b>2</b>	
<b>E</b>	 <b>REALS009</b> Shelf Support Pin	<b>8</b>	<b>1</b>		 <b>AGDCHB</b>		
<b>F</b>	 <b>REALS191</b> Handle w/ Screws	<b>2</b>					

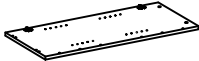
Items with HB are in hardware box.  
\*\*Denotes Color Code

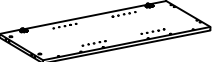
# PARTS LIST

Name	Part	Qty.	Name	Part	Qty.
<b>N</b>	 <b>AGDCN**</b> Top	<b>1</b>	<b>S</b>	 <b>AGDCS**</b> Bottom	<b>1</b>
<b>P</b>	 <b>AGDCP**</b> Right Side Panel	<b>1</b>	<b>T</b>	 <b>AGDCT**</b> Moveable Shelf	<b>2</b>
<b>Q</b>	 <b>AGDCQ**</b> Left Side Panel	<b>1</b>	<b>U</b>	 <b>AGDCU**</b> Glass Doors	<b>2</b>
<b>R</b>	 <b>AGDCR**</b> Back Panel	<b>1</b>			

\*\*Denotes Color Code

**2**

**1** Attach Door Stop (J) to Top (M) using Screws (K).

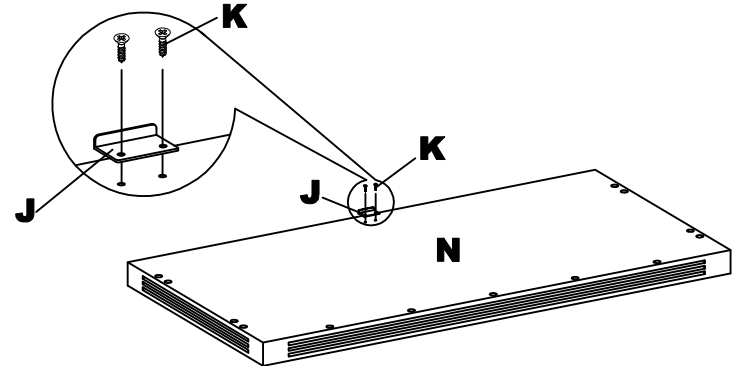

**3**

**2**

Insert Wood Dowels (A) into Bottom (S). Insert Cams (C) into Bottom (S). Install Cam Posts (B) into threaded inserts in Back Panel (R). Attach Bottom (S) to Back Panel (R) by turning Cams (C).

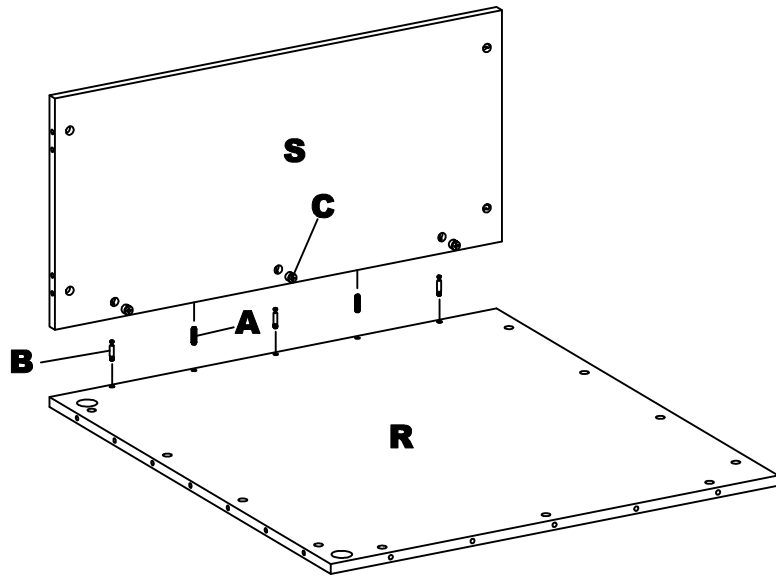

NOTE: The arrow on the face of the Cam (C) should point towards the Cam Post (B) for proper alignment.

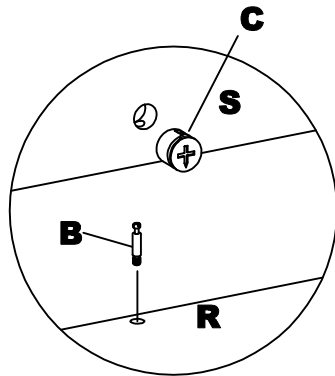
**4****3**

Insert Wood Dowels (A) into Back Panel (R) and in Bottom (S). Insert Cams (C) into Back Panel (R) and in Bottom (S). Install Cam Posts (B) into threaded inserts in Side Panels (P & Q). Attach Side Panels (P & Q) to Back Panel (R) and Bottom (S) by turning Cams (C).

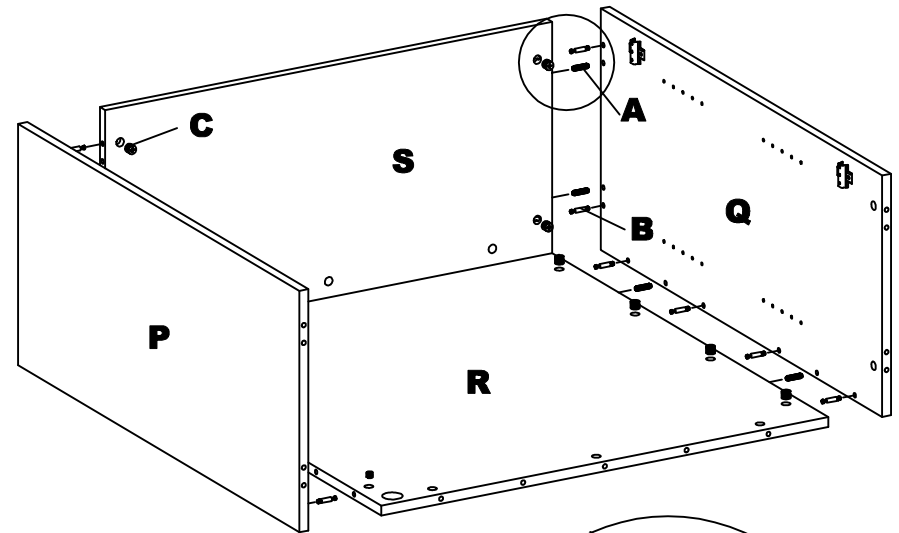

NOTE: The arrow on the face of the Cam (C) should point towards the Cam Post (B) for proper alignment.

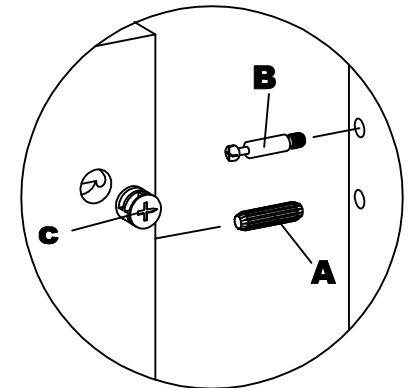
**5**

- 4** Insert Wood Dowels (A) into tops of Back Panel (R) and Side Panels (P & Q). Insert Cams (C) into Back Panel (R) and Side Panels (P & Q). Install Cam Posts (B) into threaded inserts in Top (N). Attach Top (N) to Back Panel (R) and Side Panels (P & Q) by turning Cams (C).

Apply Foam Tape (H) to bottom edge of Left and Right Side Panel (P & Q) and Back Panel (R).

Apply Cam Stickers (D) over exposed Cams (C).

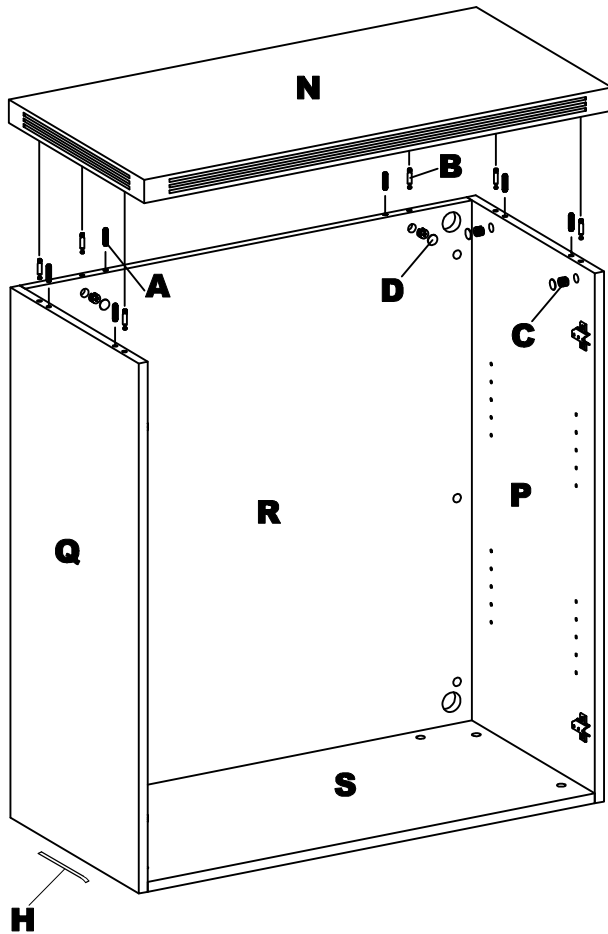

**6**

- 5** Install Grommets (G) into Back Panel (R).

Install Shelf Support Pins (E) into Left and Right Side Panel (P & Q).  
Install Moveable Shelves (T).

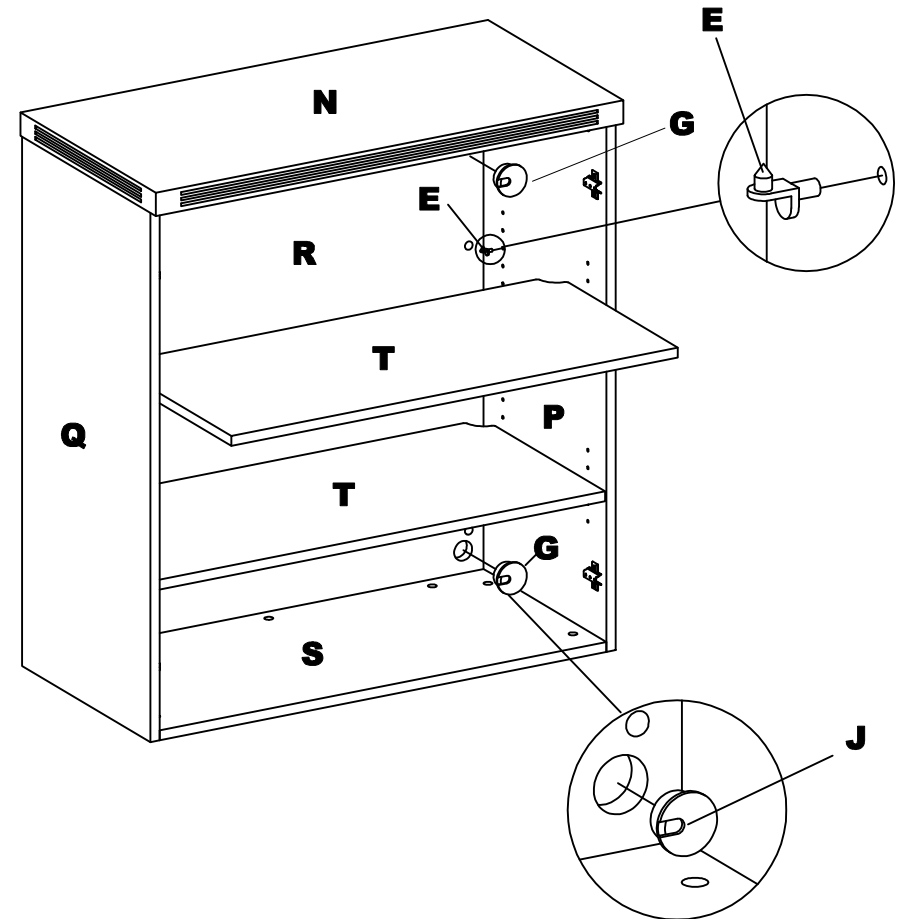

**7**



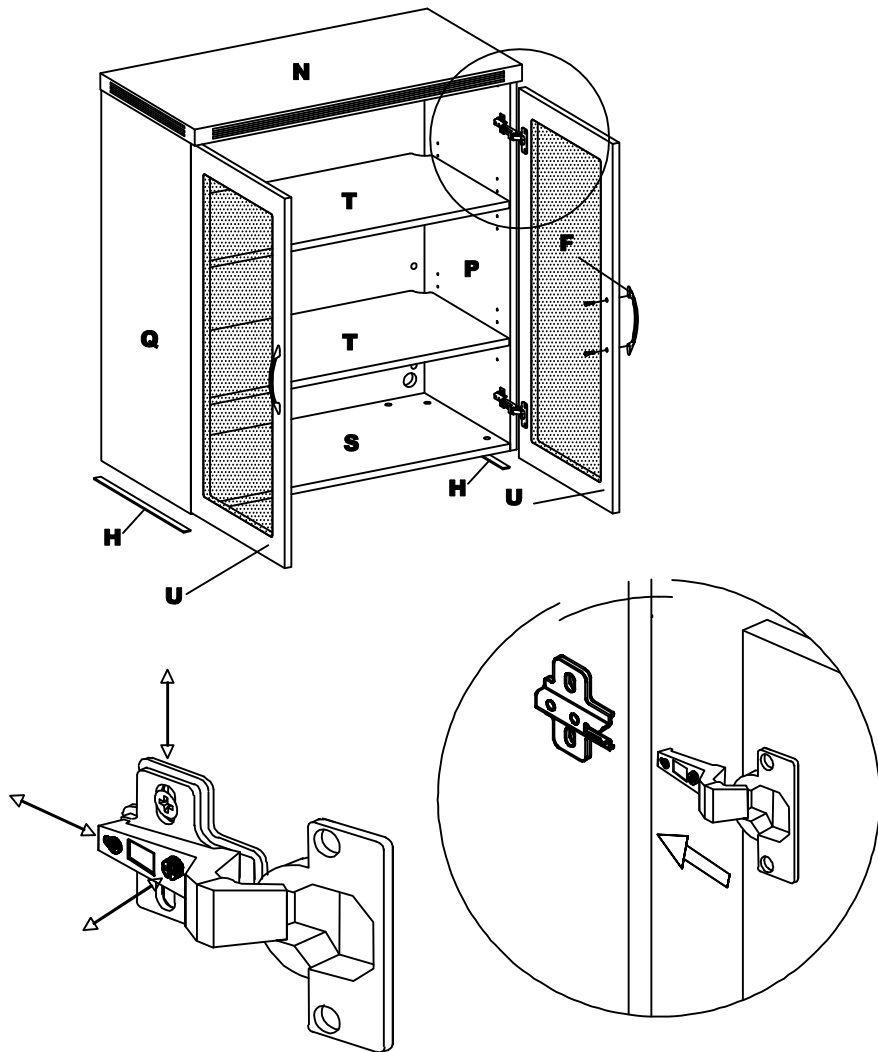

**6** Attach Handles (F) to Glass Doors (U) using screws supplied with Handle. Install Glass Doors (U) onto cabinet.

Adjust doors for alignment as necessary by using the adjustment screws on the hinges. **DO NOT** use Power Driver to make these adjustments.



**8**

## Pre-Installed Replacement Parts List

Part	Included Qty.	Part	Included Qty.
 <b>REALS013</b> Hinge - Straight	<b>4</b>	 <b>REALS013P</b> Hinge Plate - Short	<b>4</b>
 <b>REALS247</b> Bumper	<b>2</b>	 <b>REALS018</b> Ø4 x 14mm	<b>16</b>

**9**