

WC12926  
WC24526  
WC24426  
WC36726  
WC48526  
WC60326  
WC67526  
WC72426



Can we help you?

THE BUSH BUSINESS FURNITURE

# difference

- QUALITY
- INNOVATION
- SERVICE
- VALUE

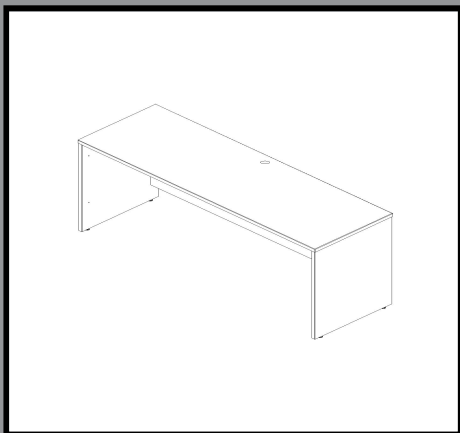

A177062



BUSH BUSINESS FURNITURE

**Thank you for purchasing this Bush Business Furniture product.** We trust that you will be completely satisfied with your product for many years to come. Bush Business Furniture products are backed by a 10-year warranty and crafted with today's styles in mind for the way you live. **Do not return product to store, contact us first at 1-800-950-4782.**

**Merci d'avoir acheté ce produit Bush Business Furniture.** Nous sommes sûr que vous serez complètement satisfait de votre meuble pendant de nombreuses années. Les produits Bush Business Furniture sont garantis pendant 10 ans et sont conçus dans les styles actuels tout en gardant à l'esprit votre façon de travailler. **Ne renvoyez pas le produit au magasin, contactez-nous d'abord au 1-800-950-4782.**

**Gracias por comprar este producto de Bush Business Furniture.** Confiamos que usted estará completamente satisfecho con su mueble por muchos años. Los productos de Bush Business Furniture tienen 10 años de garantía y son diseñados con los estilos de hoy en mente para la manera que usted vive. **No devuelva el producto a la tienda, primero comuníquese con nosotros al 1-800-950-4782.**

**10-Year**  
Manufacturer's  
Warranty

[www.bbffits.com](http://www.bbffits.com)



## CONTACT US

Monday – Friday

8:30 a.m. – 7:30 p.m. ET  
(Except Holidays)

Bush Consumer Services  
One Mason Drive, P.O. Box 460  
Jamestown, NY 14701  
ConsumerService@Bushindustries.com

**1-800-950-4782 USA/CANADA**

**001-800-950-4782 MEXICO**

Se habla español

Outside USA/CANADA/MEXICO  
001-716-665-2510 Ext. 4514

**10-Year**  
Manufacturer's  
Warranty

**REGISTER YOUR  
PRODUCT ONLINE AT**

[http://www.bushfurniture.com/  
ProductRegistration.aspx](http://www.bushfurniture.com/ProductRegistration.aspx)

# IT'S AS EASY AS 1,2,3

## Assembly tips:

1. Read the instructions and become familiar with the parts.
2. Ensure this carton contains all parts, fasteners and hardware.
3. To protect floors, assemble the furniture on the carton.
4. An assistant may be helpful.
5. Use of power tools is not recommended.

## Conseils d'assemblage:

1. Lisez les instructions et familiarisez-vous avec les pièces.
2. Assurez-vous que le carton contient toutes les pièces, toutes les pièces de fixation et toute la quincaillerie.
3. Pour protéger vos sols, assemblez le meuble sur le carton.
4. Il peut être utile de vous faire aider.
5. L'utilisation d'outils électriques n'est pas recommandée.

## Consejos de Ensamblaje:

1. Lea las instrucciones y familiarícese con las partes.
2. Asegúrese de que esta caja contenga todas las piezas, los sujetadores y el equipo.
3. Para proteger el piso, ensamble el mueble en el carton.
4. Un asistente puede serle útil.
5. El uso de herramientas eléctricas no se recomienda.

## CONSUMER SERVICE YOU CAN DEPEND ON

**Questions?** Operators are standing by at our TOLL-FREE help line to assist you with assembly; and, if necessary, to quickly replace damaged/missing parts. Assistance is available 5 days a week. Simply have your store receipt, instruction manual, and part number/description ready when you call our TOLL-FREE help line. It's that easy.

## UN SERVICE CLIENTELE SUR LEQUEL VOUS POUVEZ COMPTER

**Des questions?** Des opérateurs sont prêts sur notre ligne d'assistance GRATUITE pour vous aider à l'assemblage et, si nécessaire, remplacer rapidement les pièces endommagées/manquantes. L'assistance est disponible 5 jours par semaine. Ayez simplement votre reçu de magasin, votre manuel d'instruction et le numéro de pièces/description à votre disposition lorsque vous appelez notre ligne d'assistance GRATUITE. C'est aussi simple que ça.

## SERVICIO AL CONSUMIDOR CON EL QUE PUEDE CONTAR

**¿Preguntas?** Los operadores están listos para ayudarlo con el ensamblaje a través de una línea de ayuda GRATUITA, y en caso de ser necesario, reemplazar de inmediato las piezas dañadas o faltantes. La asistencia está disponible los 5 días de la semana. Solamente tenga listos su recibo de compra, manual de indicaciones y número/descripción de la pieza al momento de llamarnos a la línea de ayuda GRATUITA.

Es así de sencillo.

# IMPORTANT SAFETY INFORMATION



## WARNING

This product is designed and intended for use with computer, fax, and printer equipment only. Improper loading with television or other heavy equipment could cause instability, tip over, and/or serious injury.

Este producto esta diseñado solamente para el uso con computadores, faxes, e impresoras. Inapropiado uso al poner televisores u otro equipo pesado puede causar inestabilidad, rodamiento, y/o herida (golpes) serios.

Ce produit est uniquement conçu pour une utilisation avec un ordinateur, un télécopieur, ou une imprimante. Un chargement incorrect avec une télévision ou autre matériel lourd peut le rendre instable ou le renverser, et peut vous causer des endommagements sérieux.



## WARNING

Do not move unit when loaded. Doing so could cause instability, product collapse, tip over, and/or serious injury.

No mueva la unidad cuando esté cargada. Hacerlo puede causar inestabilidad, que el producto se derrumbe, que se la caiga encima y/o heridas (golpes) serias.

Ne pas déplacer l'unité lorsqu'elle est chargée. Faire ainsi peut causer l'instabilité, l'effondrement ou le renversement du meuble et/ou des endommagements sérieux.

# EXPLODED VIEW

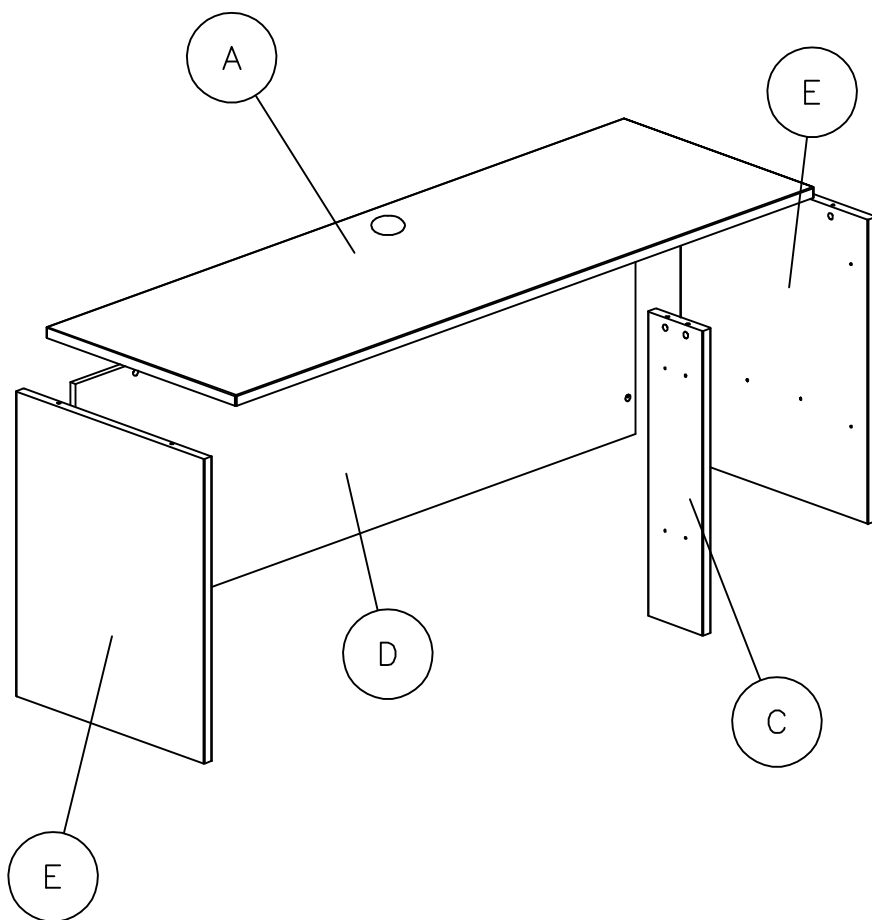
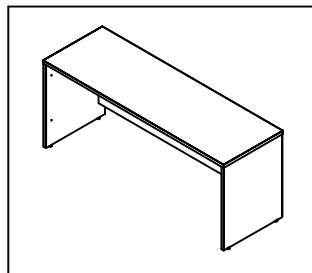

 1-800-950-4782

**A177062**

# PARTS LIST

## WC12926

A [1] W177063  
C [1] W127725  
D [1] W177064  
E [2] W127727

## WC24426

A [1] W176083  
C [1] W92869  
D [1] W177066  
E [2] W129132

## WC24526

A [1] W176083  
C [1] W176075  
D [1] W176084  
E [2] W176074

## WC36726

A [1] W177067  
C [1] W127730  
D [1] W177068  
E [2] W127732

## WC48526

A [1] W177069  
C [1] W92869  
D [1] W177066  
E [2] W129132

## WC60326

A [1] W177070  
C [1] W127735  
D [1] W177071  
E [2] W127737

## WC67526

A [1] W177072  
C [1] W151979  
D [1] W177073  
E [2] W151981

## WC72426

A [1] W177074  
C [1] W92869  
D [1] W177066  
E [2] W129132

# FASTENERS

Fasteners are shown in actual size.

Los fijadores son demostrados en su tamaño actual.

Les attaches sont montrées dans l'échelle grandeur.

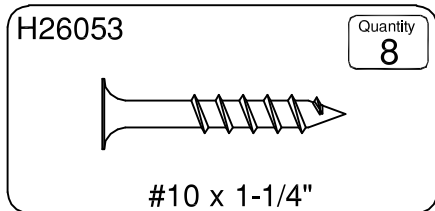
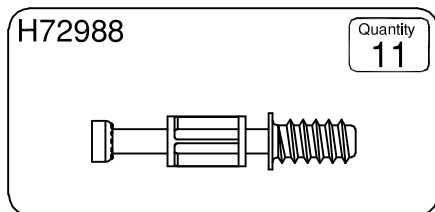
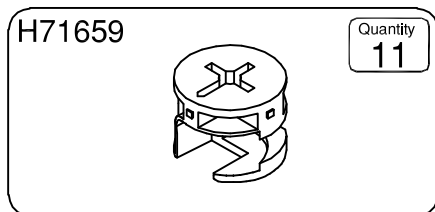
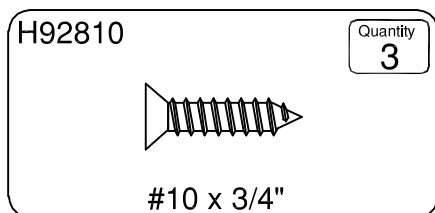
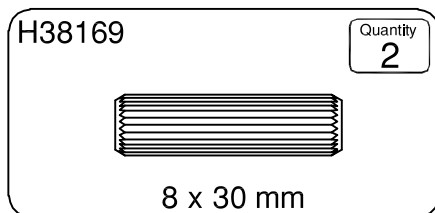

# HARDWARE

H24807

Quantity  
1

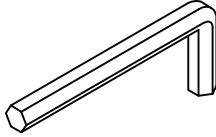

H24806

Quantity  
4

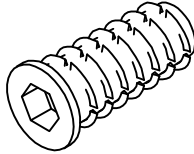

H39696

Quantity  
4

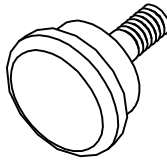

H30767

Quantity  
4

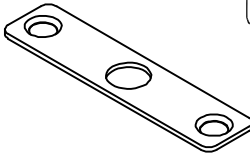

H92809

Quantity  
1

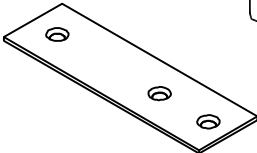

H118700

Quantity  
1

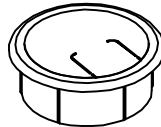

# MODEL SPECIFIC

## WC12926

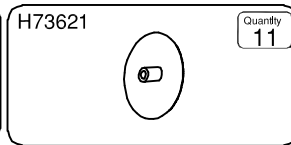
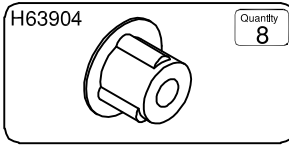

## WC24426, WC48526, WC72426

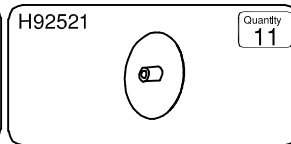
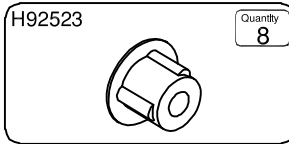

## WC24526

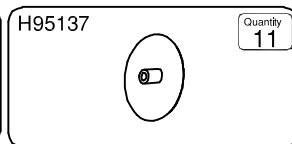
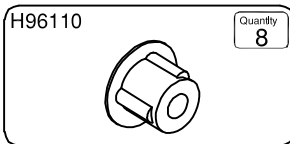

## WC36726

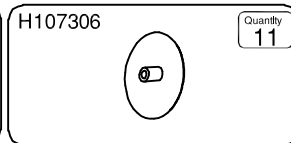
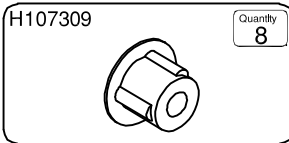

## WC60326

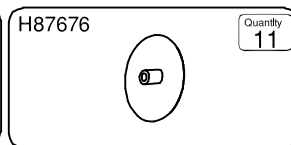
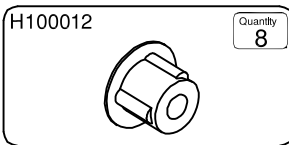

## WC67526

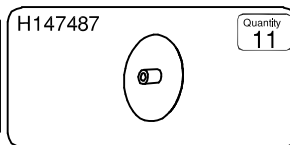
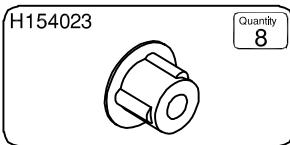



# ATTENTION

Common assembly techniques.  
Técnica común de ensamblaje.  
Techniques communes d'assemblage.

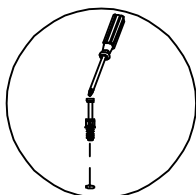

- Use a screwdriver with H72988.
- Favor de usar un desarmador con el tornillo H72988.
- Utilisez un tournevis avec H72988.

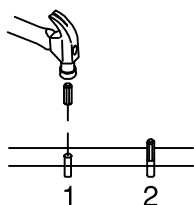

- Wood dowel installation.
- Instalación del tornillo de madera.
- Installation de chevilles de bois.

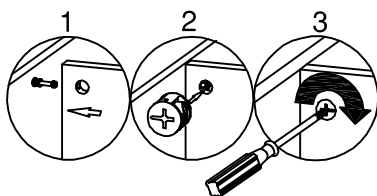

- Panel to panel attachment.
- Fijación de tablero con tablero.
- Fixation d'un panneau à l'autre

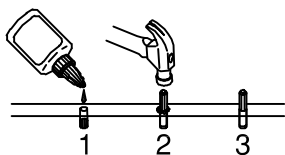

- Wood dowel installation with glue.
- Instalación del tornillo de madera con pegamento.
- Installation de chevilles de bois avec la colle.

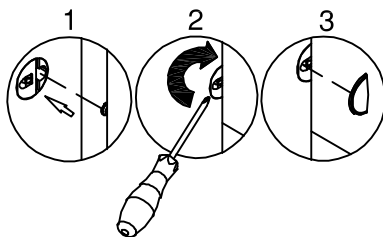

- Panel to panel attachment.
- Fijación de tablero con tablero.
- Fixation d'un panneau à l'autre

# STEP 1

WC12926, WC24426,  
WC24526, WC36726  
WC48526, WC60326,  
WC67526, WC72426

Go to step 3.  
Proceda al paso #3.  
Allez à l'étape 3.

---

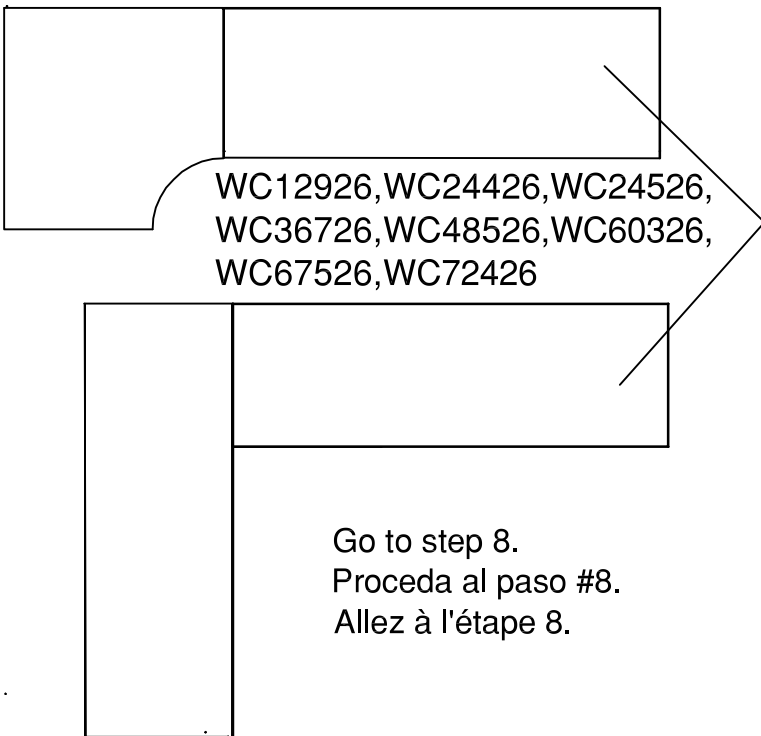

WC12926, WC24426, WC24526,  
WC36726, WC48526, WC60326,  
WC67526, WC72426

Go to step 8.  
Proceda al paso #8.  
Allez à l'étape 8.

## STEP 2

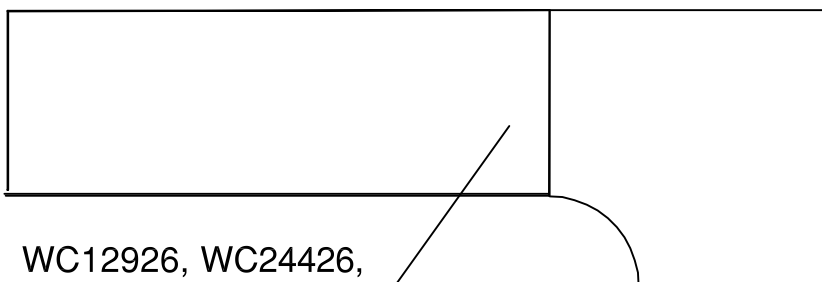

WC12926, WC24426,  
WC24526, WC36726  
WC48526, WC60326,  
WC67526, WC72426

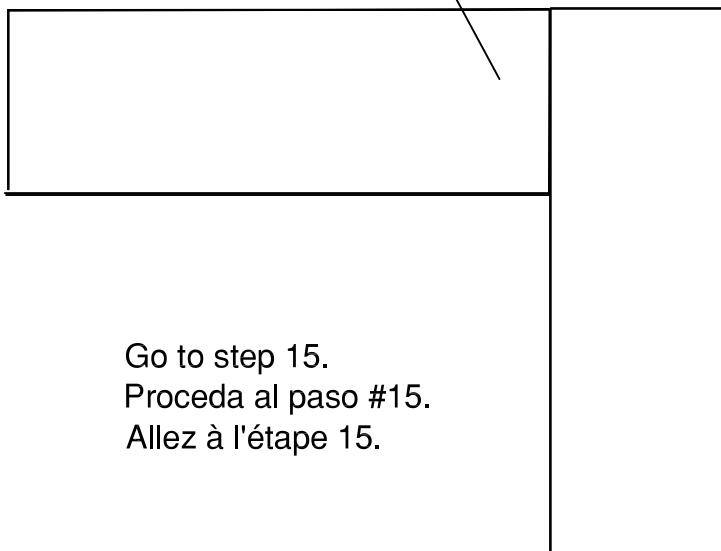

Go to step 15.  
Proceda al paso #15.  
Allez à l'étape 15.

# STEP 3

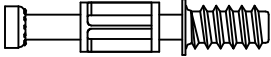
H72988  [ 2 ]

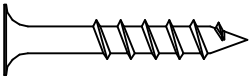
H26053  [ 4 ]

H39696  [ 2 ]

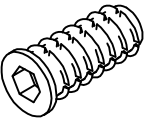
H24806  [ 2 ]

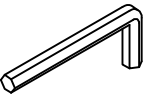
H24807  [ 1 ]

H63904		Quantity
H107309		4
H100012		
H154023		
H92523		
H96110		

H30767  [ 2 ]

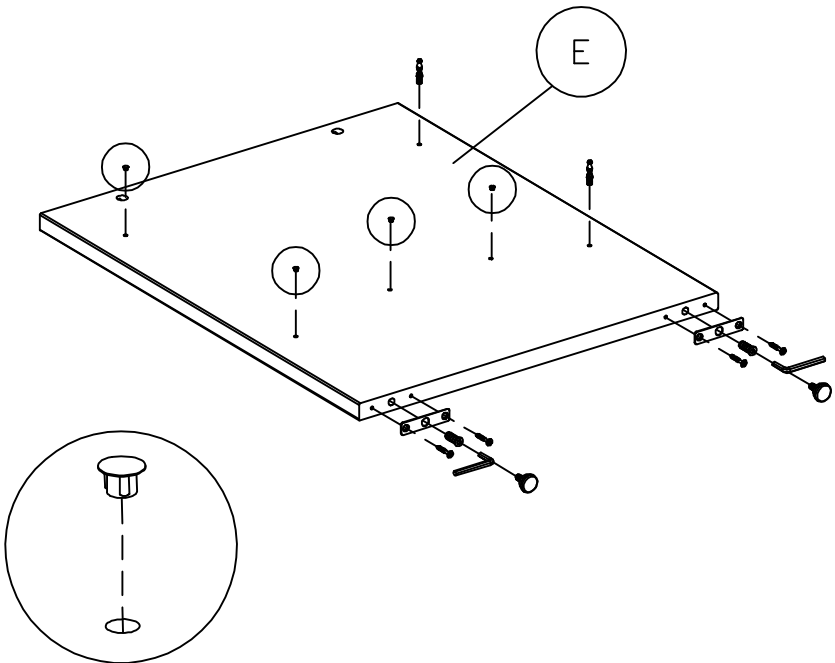

 1-800-950-4782

A177062

# STEP 4

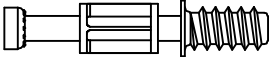
H72988  [ 2 ]

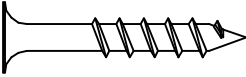
H26053  [ 4 ]

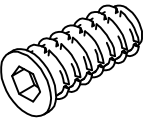
H24806  [ 2 ]

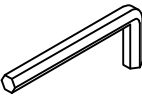
H24807  [ 1 ]

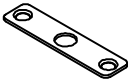
H30767  [ 2 ]

H39696  [ 2 ]

H63904		Quantity
H107309		4
H100012		
H154023		
H92523		
H96110		

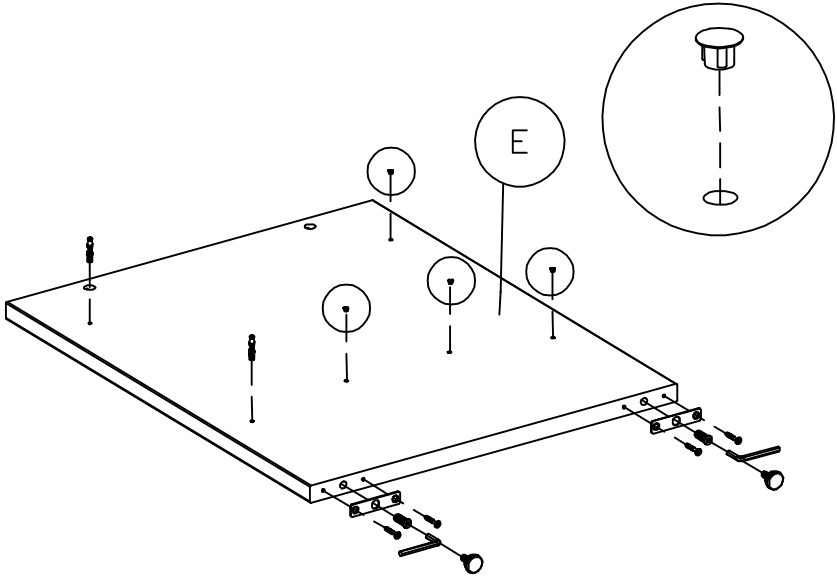

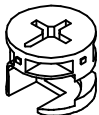

# STEP 5

H71659  [ 4 ]

H38169  [ 2 ]

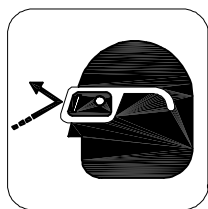
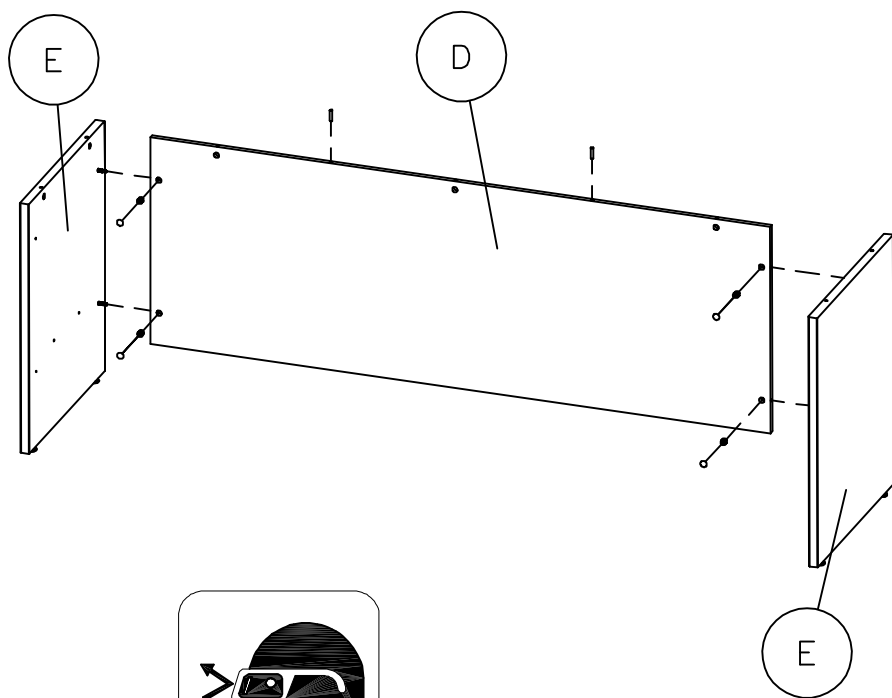
H73621		Quantity
H107306		4
H87676		
H147487		
H92521		
H95137		



 1-800-950-4782

A177062

# STEP 6

H72988



[ 7 ]

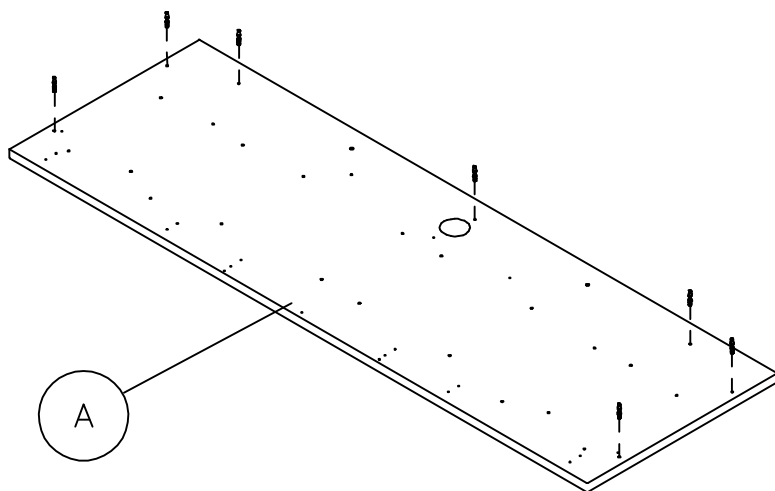

# STEP 7

H71659

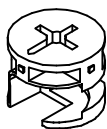

[ 7 ]

An assistant is required.  
Es necesario un ayudante.  
Un assistant est nécessaire.

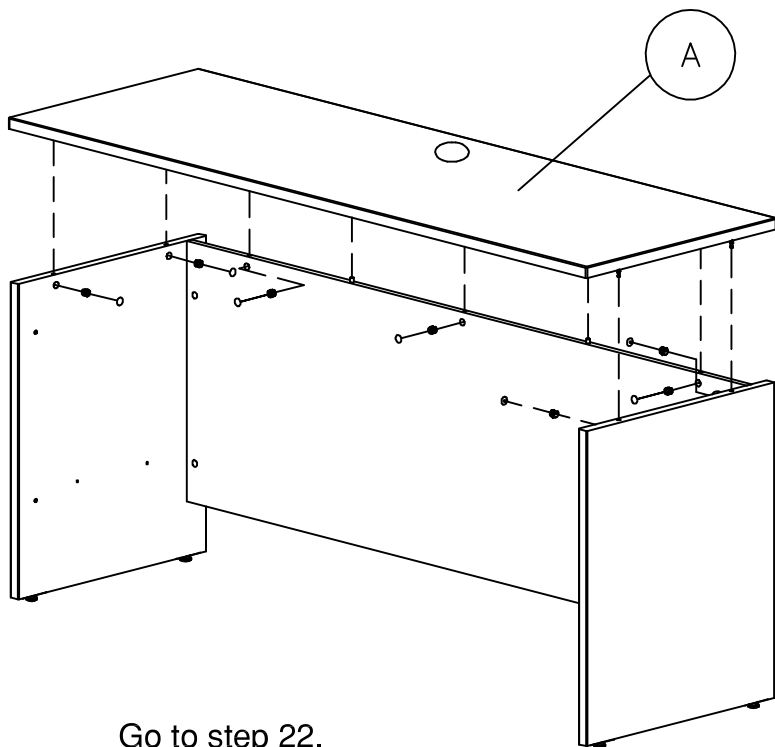
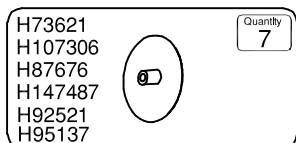

Go to step 22.  
Proceda al paso #22.  
Allez à l'étape 22.

 1-800-950-4782

A177062



# STEP 8

H72988 [ 2 ]

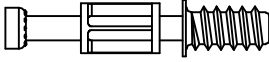

H63904  
H107309  
H100012  
H154023  
H92523  
H96110



Quantity  
2

H39696 [ 2 ]



H24806 [ 2 ]

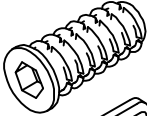

H24807 [ 1 ]

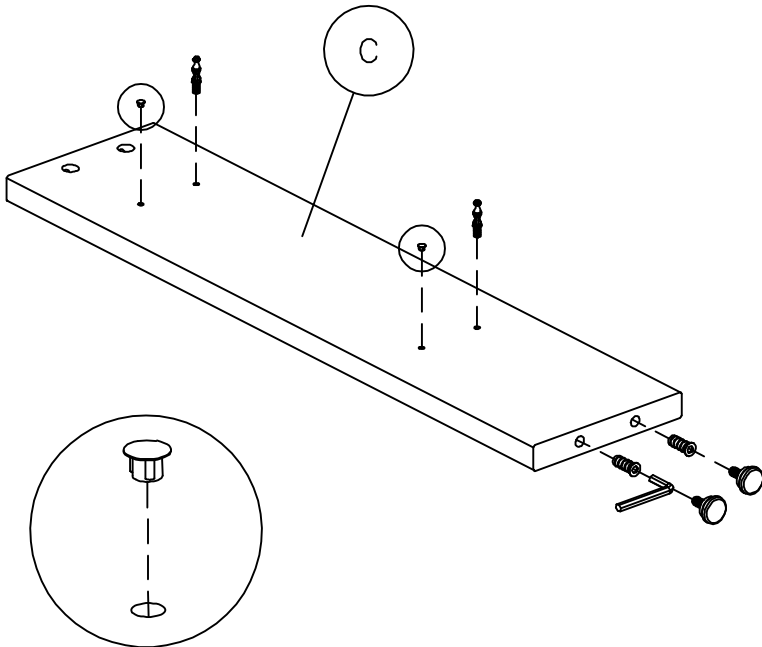

 1-800-950-4782

A177062

# STEP 9

H71659



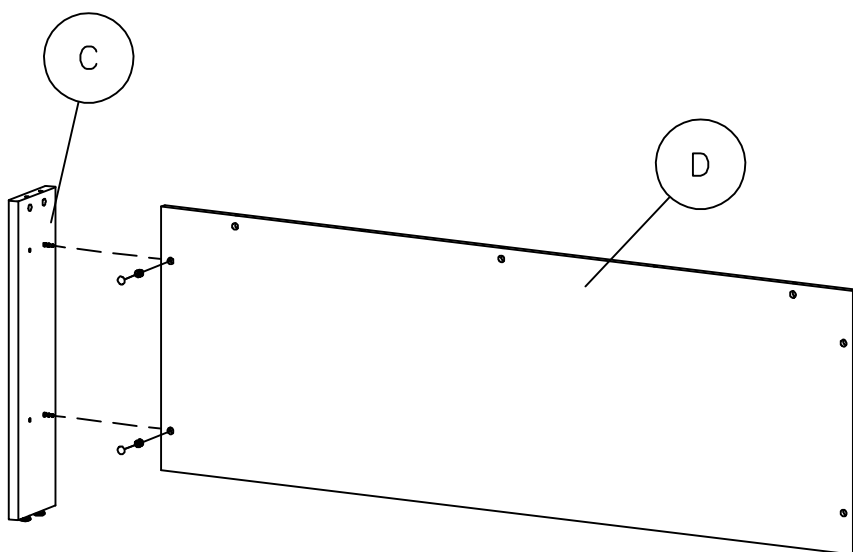

[ 2 ]

H73621		Quantity
H107306		2
H87676		
H147487		
H92521		
H95137		

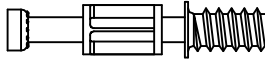

# STEP 10

H72988  [ 2 ]

H39696  [ 2 ]

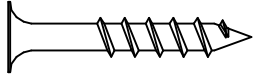
H26053  [ 4 ]

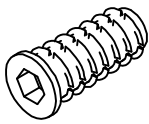
H24806  [ 2 ]

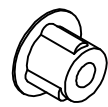
H63904		Quantity
H107309		4
H100012		
H154023		
H92523		
H96110		

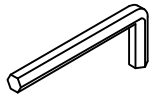
H24807  [ 1 ]

H30767  [ 2 ]

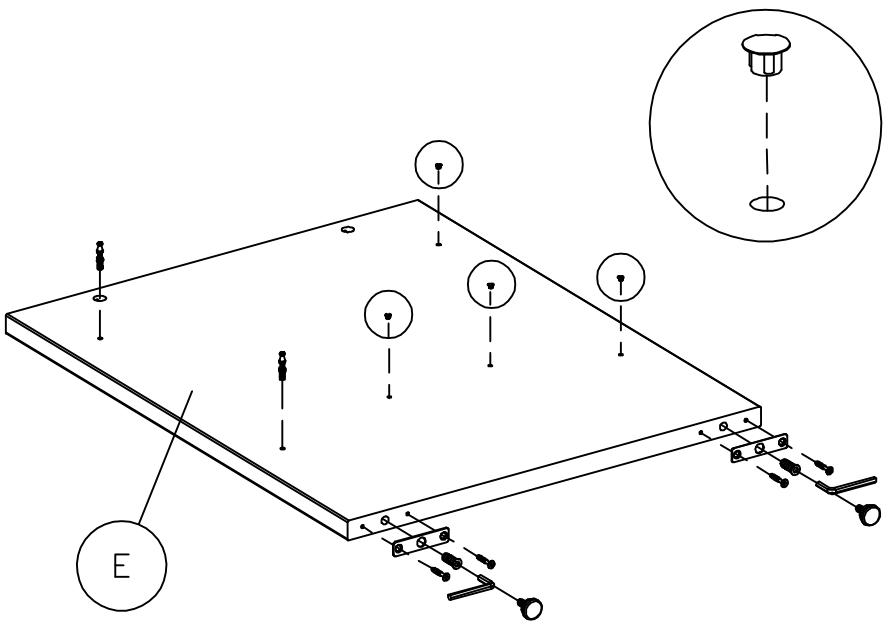

 1-800-950-4782

A177062

# STEP 11

H71659

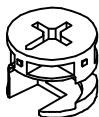

[ 2 ]

H73621  
H107306  
H87676  
H147487  
H92521  
H95137





Quantity  
2

H38169

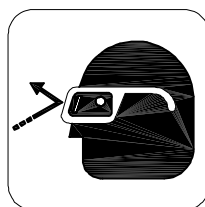
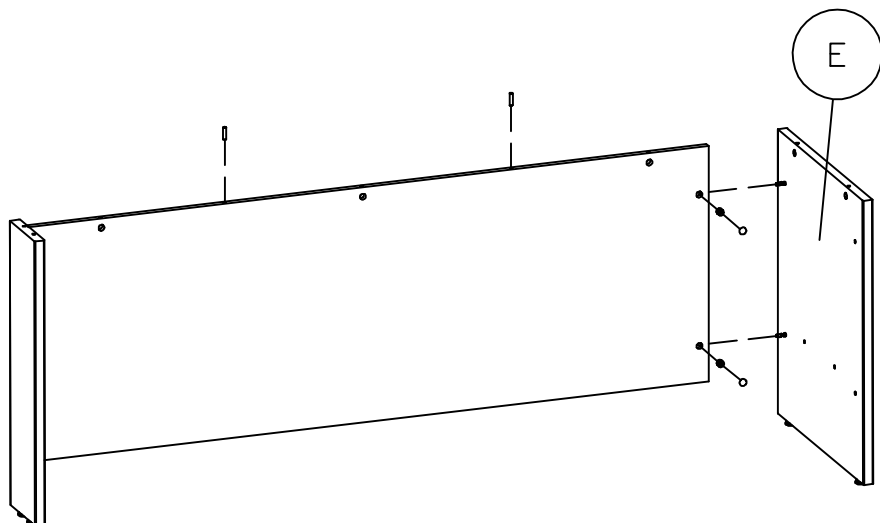

[ 2 ]



 1-800-950-4782

A177062

# STEP 12

H72988

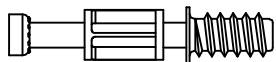

[ 6 ]

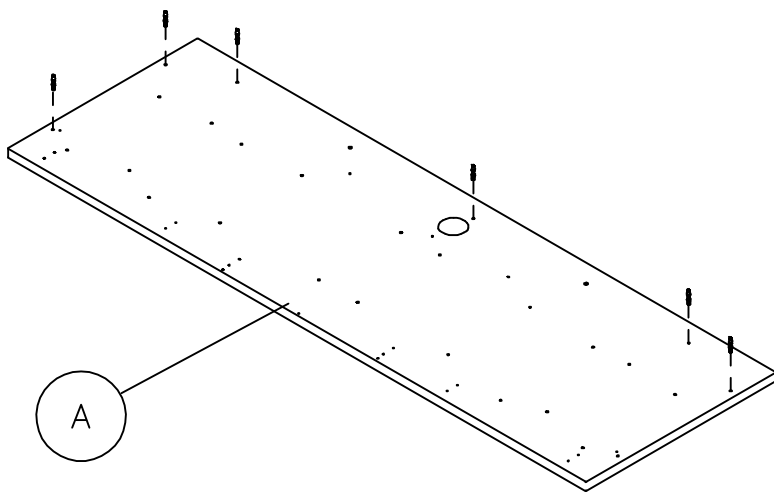

## STEP 13

H71659

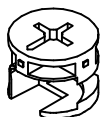

[ 6 ]

An assistant is required.  
Es necesario un ayudante.  
Un assistant est nécessaire.

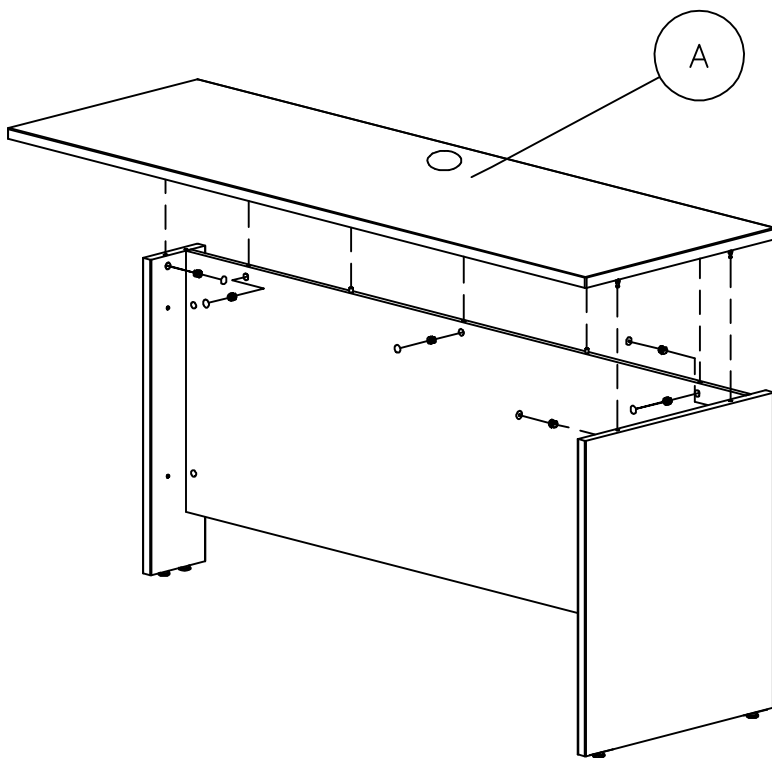
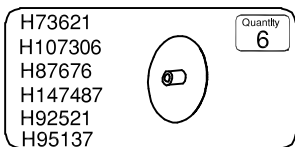

 1-800-950-4782

A177062

## STEP 14

H92809

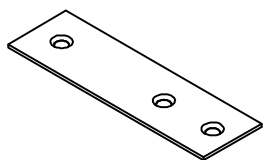

[ 1 ]

H92810

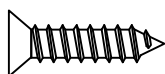

[ 3 ]

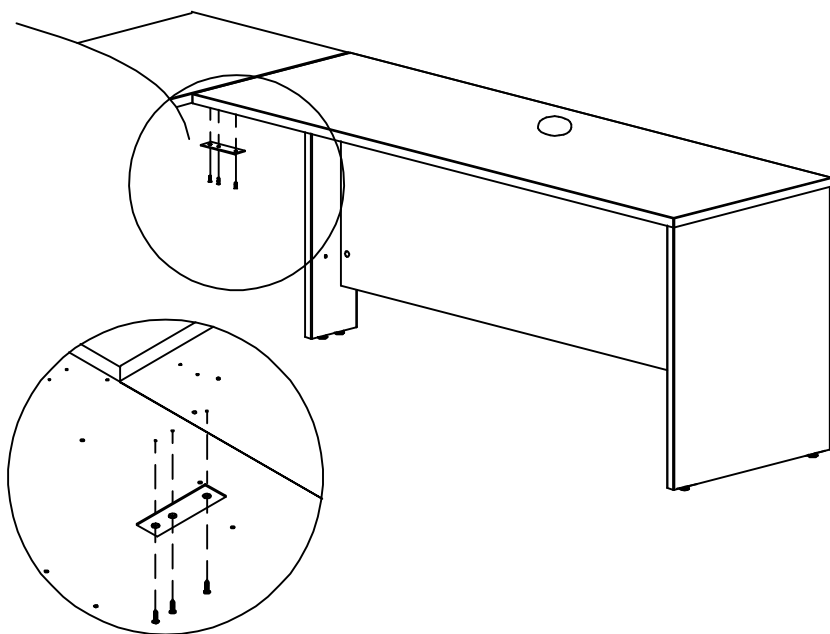

Go to step 22.

Proceda al paso #22.

Allez à l'étape 22.

 1-800-950-4782

A177062

# STEP 15

H72988 [ 2 ]

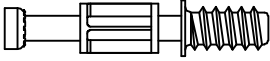

H63904  
H107309  
H100012  
H154023  
H92523  
H96110



Quantity  
2

H39696 [ 2 ]



H24806 [ 2 ]

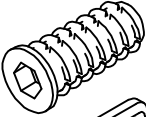

H24807 [ 1 ]

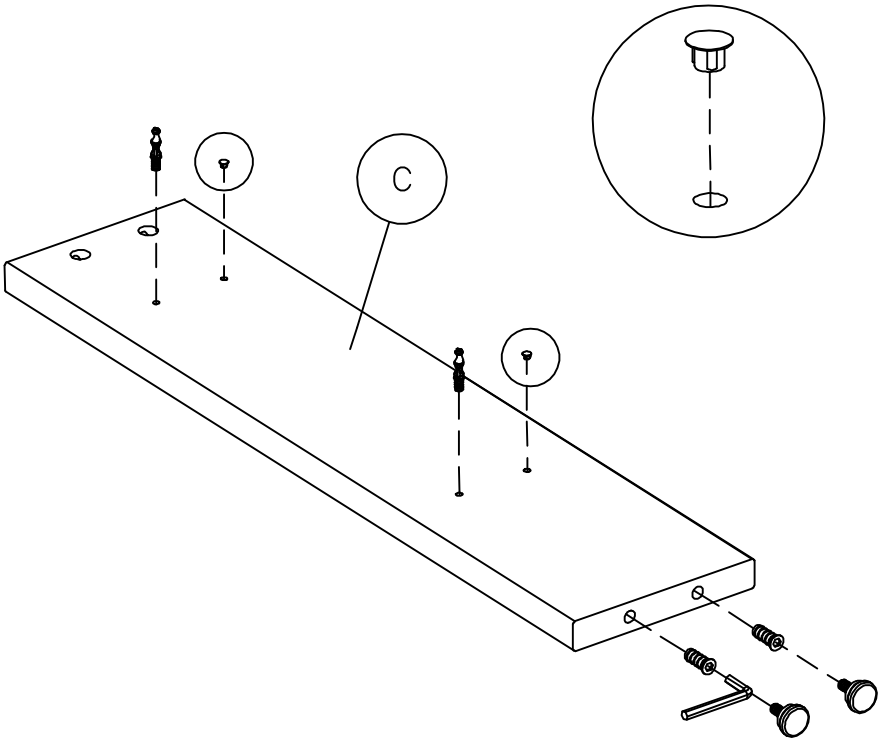

 1-800-950-4782

A177062



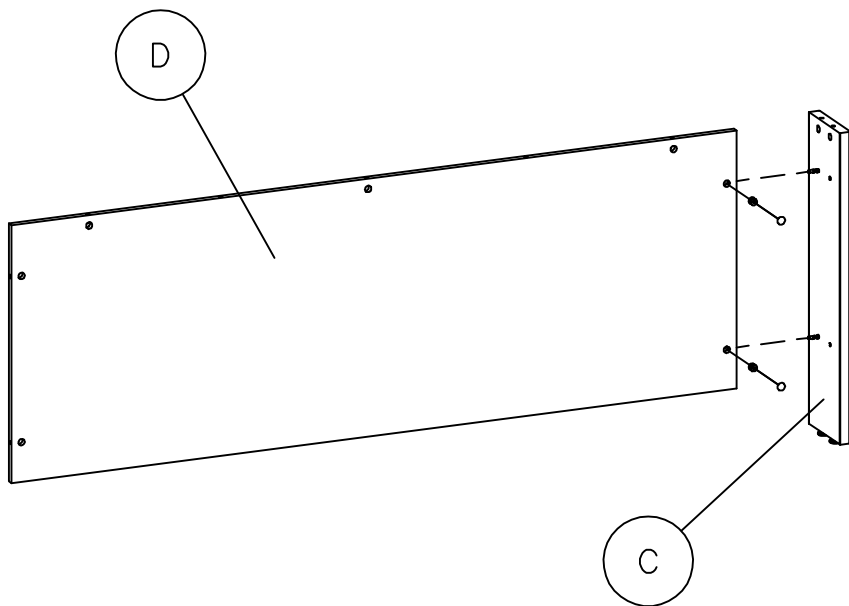
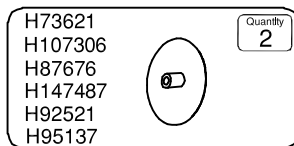
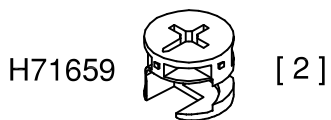

# STEP 16



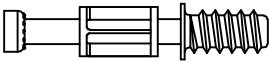

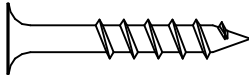
# STEP 17

H72988  [ 2 ]

H26053  [ 4 ]

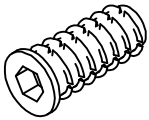
H39696  [ 2 ]

H24806  [ 2 ]

H63904 H107309 H100012 H154023 H92523 H96110		Quantity 4
---	---	---------------

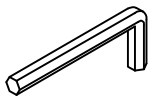
H24807  [ 1 ]

H30767  [ 2 ]

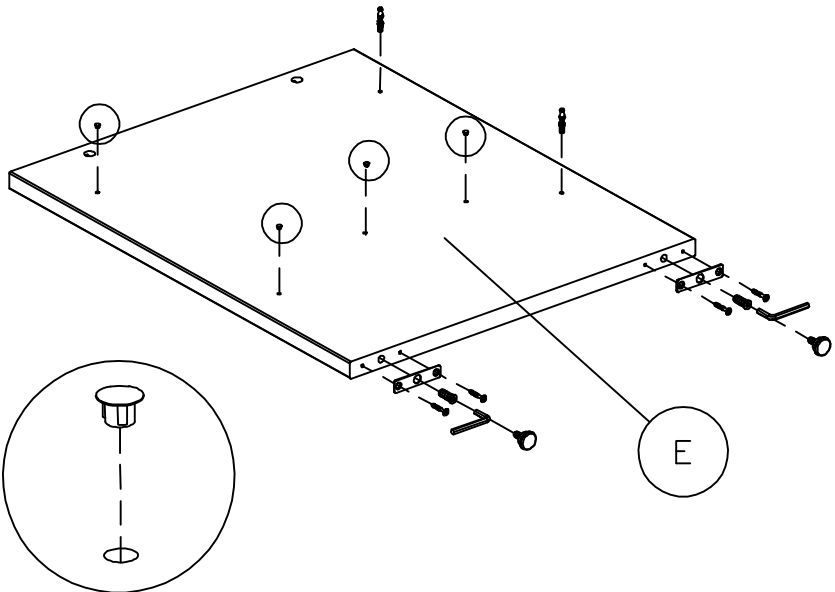

 1-800-950-4782

A177062

# STEP 18

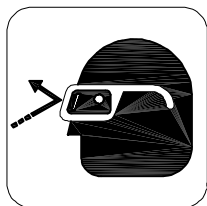
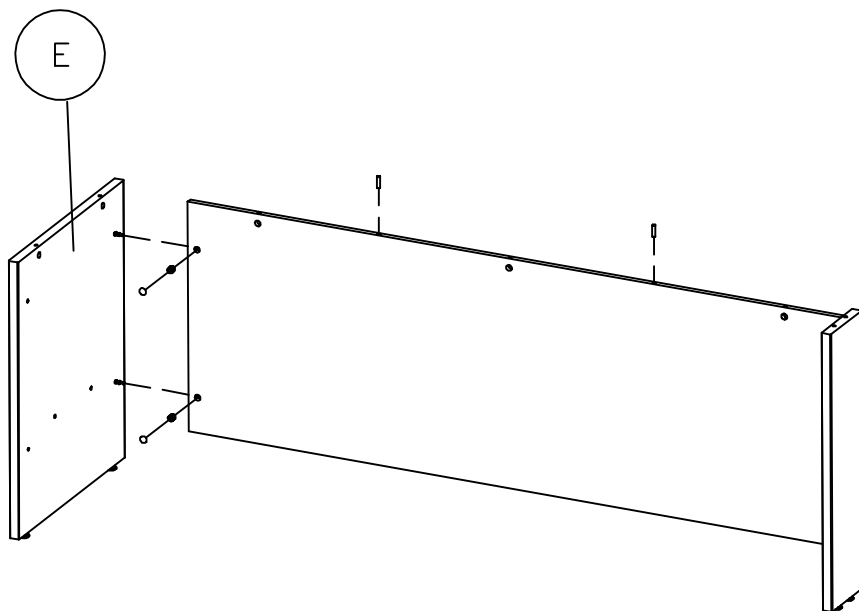
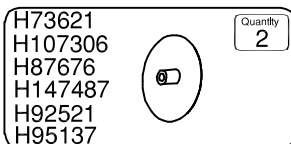
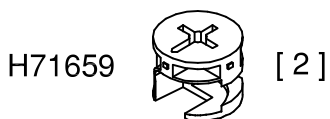

 1-800-950-4782

A177062

# STEP 19

H72988  [ 6 ]

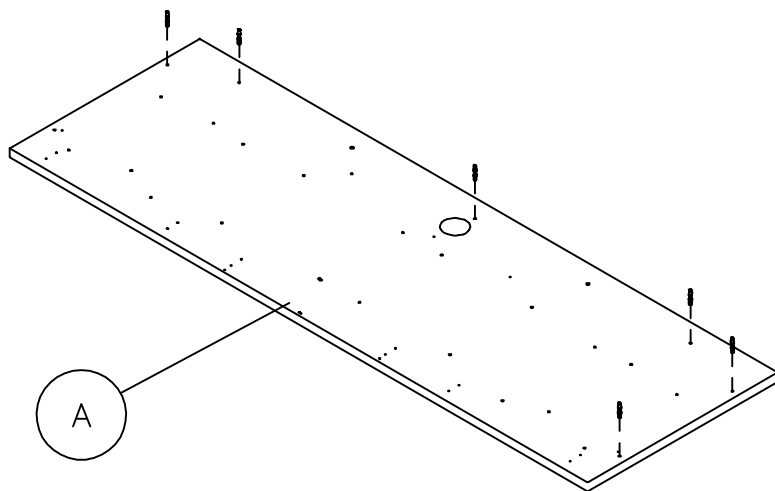

# STEP 20

H71659



[ 6 ]

An assistant is required.  
Es necesario un ayudante.  
Un assistant est nécessaire.

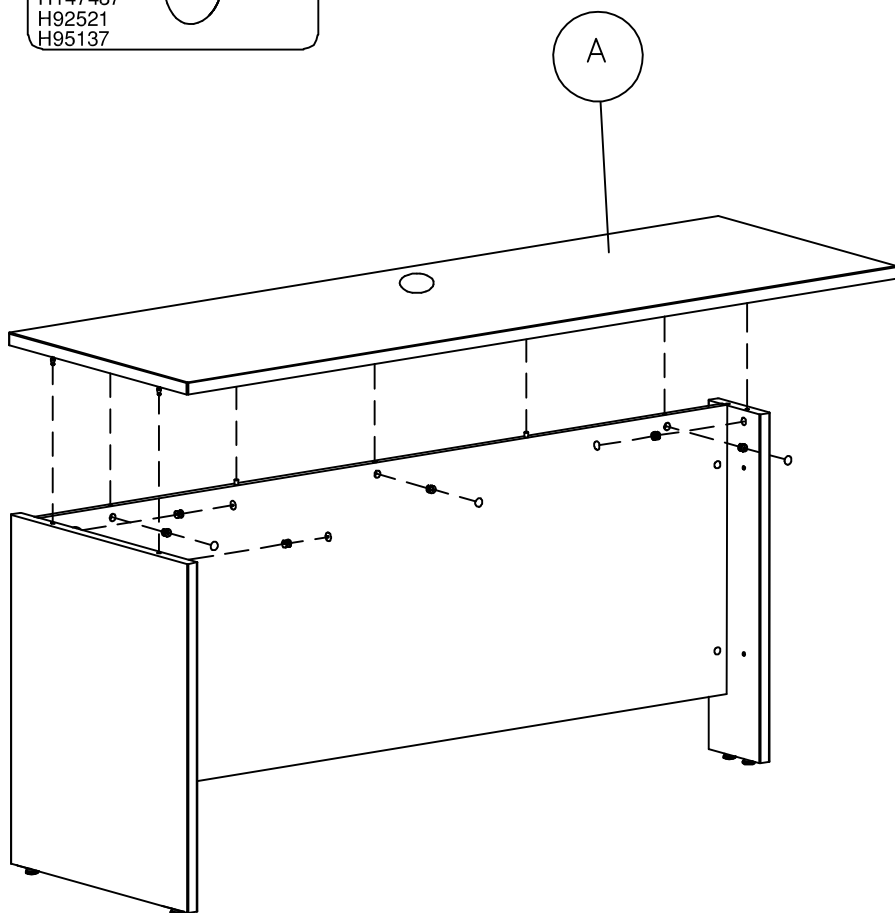
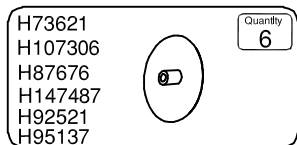

# STEP 21

H92809

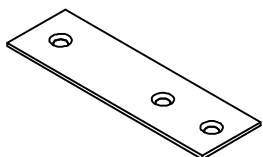

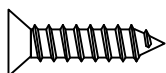

[ 1 ]

H92810

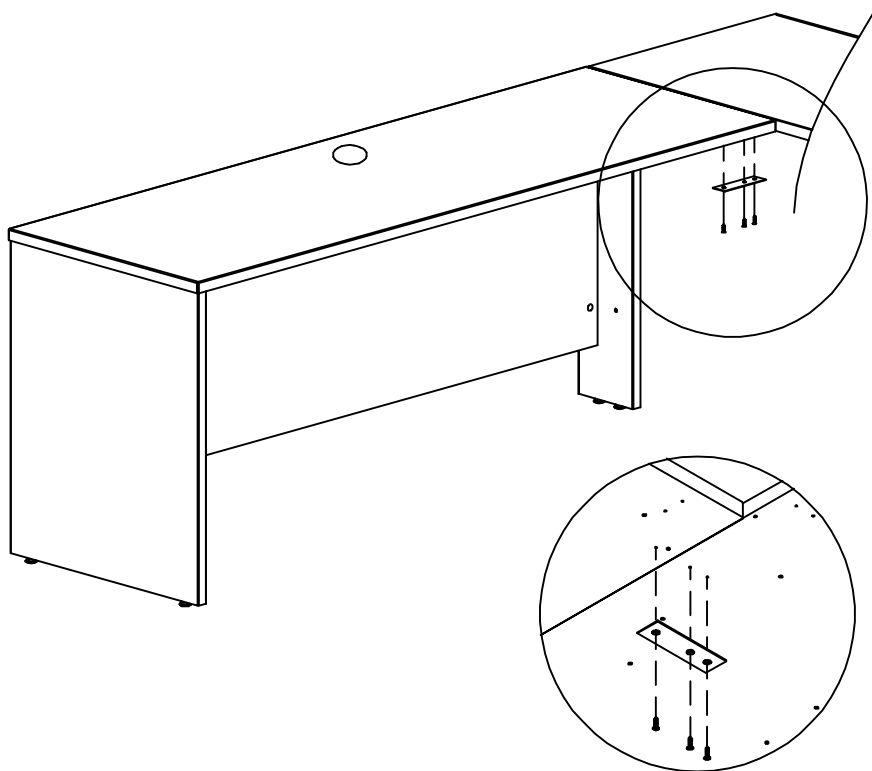

[ 3 ]



 1-800-950-4782

A177062

# STEP 22

H118700

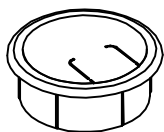

[ 1 ]

Maximum Weight: 200 Lbs.  
Peso Máximo: 200 Libras  
Poids Maximum: 74.6 kilogramme

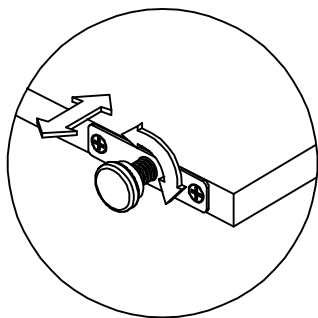
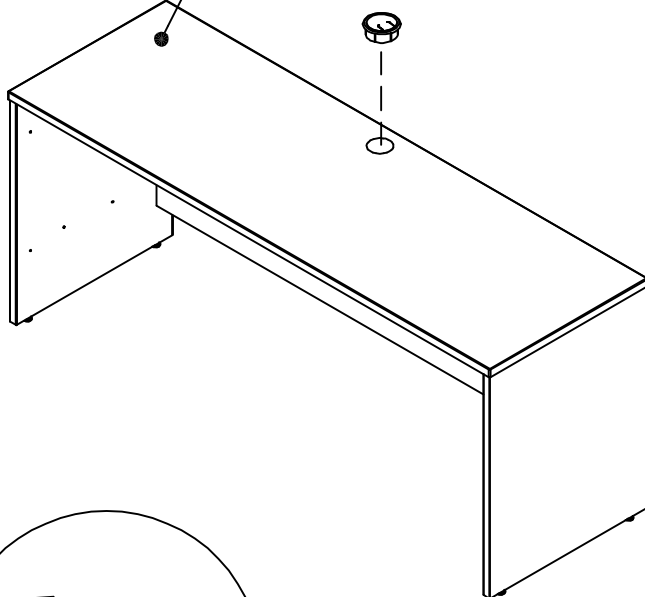

 1-800-950-4782

A177062



## WARRANTY INFORMATION/INFORMATIONS POUR LA GARANTIE/INFORMACIÓN DE GARANTÍA

### BUSH BUSINESS FURNITURE'S WRITTEN WARRANTY TO YOU

In order to provide you with timely assistance, please thoroughly inspect your furniture for missing or defective parts immediately after opening the carton. To receive replacement or missing parts under this warranty, call our Consumer Service Department TOLL-FREE at 1-800-950-4782. Please have the Model, Part, and Lot Numbers found in the instruction manual available for your reference. You will also need your sales receipt or other proof of purchase. Replacement part(s) will be shipped to you at no charge with Bush Industries assuming all shipping and handling charges.

This Bush Business Furniture product is warranted to the original purchaser at the time of purchase and for a period of ten years thereafter.

We warrant to you, the original purchaser, that our furniture and all its parts and components are free of defects in material or workmanship. "Defects," as used in this warranty, is defined as any imperfection which impairs the use of the furniture product.

Our warranty is expressly limited to the replacement of furniture parts and components. For ten years after the date of purchase, Bush will replace any parts that are defective in material or workmanship.

This warranty applies under conditions of normal use. Our Bush Business Furniture products are not intended for outdoor use. This warranty does not cover: 1) defects caused by improper assembly or disassembly; 2) defects occurring after purchase due to product modification, intentional damage, accident, misuse, abuse, negligence or exposure to the elements; and 3) labor or assembly costs.

IMPLIED WARRANTIES, INCLUDING THE WARRANTY OF MERCHANTABILITY, SHALL NOT EXTEND BEYOND THE DURATION OF THE WRITTEN WARRANTY STATED ABOVE, AND IN NO EVENT SHALL BUSH BE LIABLE FOR INCIDENTAL OR CONSEQUENTIAL DAMAGES RESULTING FROM USE OF THE PRODUCT. Some states do not allow a limitation on how long an implied warranty lasts or the exclusion or limitation of incidental or consequential damages, so the above limitation and exclusion may not apply to you.

This warranty gives you specific legal rights. You may also have other rights that may vary from state to state.

### VOTRE GARANTIE BUSH BUSINESS FURNITURE

Afin de vous assister rapidement, veuillez inspecter votre mobilier en détail immédiatement après l'ouverture du carton en cas de pièces manquantes ou défectueuses. Pour recevoir une pièce de rechange ou manquante couverte par cette garantie, appelez notre département de service clientèle GRATUITEMENT au 1-800-950-4782. Veuillez tenir à disposition les numéros de modèle, de pièce et de lot qui se trouvent dans le manuel d'instruction pour votre référence. Vous aurez également besoin de votre reçu ou d'une autre preuve d'achat. La (les) pièce(s) de rechange vous sera (seront) envoyée(s) sans frais, Bush Industries se chargeant de tous les frais d'expédition.

Tout le produit Bush Business Furniture est garanti à l'acheteur original à partir de la date d'achat pour une période d'e dix ans.

Nous vous garantissons, à vous l'acheteur original, que notre mobilier et toutes ses pièces et composants sont sans défaut de matériau ou de fabrication. Le terme "défauts" utilisé dans cette garantie, est défini comme étant toutes les imperfections qui compromettent l'utilisation du meuble.

Notre garantie est expressément limitée au remplacement des pièces et des composants du mobilier. Pendant dix ans après la date d'achat, Bush remplacera toute pièce défectueuse dans le matériau ou sa fabrication.

Cette garantie d'applique sous des conditions d'utilisation normale. Nos produits ne sont pas destinés à être utilisés en plein air. Cette garantie ne couvre pas: 1) les défauts causés par un mauvais assemblage ou démontage; 2) les défauts ayant lieu après l'achat et dus à la modification du produit, des dommages intentionnels, des accidents, une mauvaise utilisation, un mauvais traitement, la négligence ou l'exposition aux éléments; et 3) les frais de main d'œuvre ou d'assemblage.

LES GARANTIES TACITES, Y COMPRIS LA GARANTIE DE QUALITE MARCHANDE, NE S'ETENDRONT PAS AU-DELA DE LA DUREE ECRITE CITEE CI-DESSUS, ET BUSH NE SERA EN AUCUN CAS RESPONSABLE DES DOMMAGES ACCESSOIRES OU INDIRECTS RESULTANT DE L'UTILISATION DU PRODUIT. Certains états ne permettent pas d'appliquer une limite à la durée de la garantie tacite, ni une exclusion ou limitation des dommages accessoires ou indirects; dans ce cas les limitations ou exclusion ci-dessus peuvent ne pas s'appliquer à vous.

Cette garantie vous donne des droits légaux spécifiques. Il se peut que vous ayez également d'autres droits qui peuvent varier d'un état à l'autre.

### GARANTIA ESCRITA DE BUSH BUSINESS FURNITURE PARA USTED

Para brindarle asistencia oportuna, por favor, verifique detalladamente que a su mueble no le falte o tenga piezas defectuosas inmediatamente después de abrir la caja. Pararecibir un reemplazo o la parte faltante bajo esta garantía, llame a nuestro Departamento de Servicio al Consumidor GRATIS al 1-800-950-4782. Sírvase traer los números de modelo, parte y lote que se encuentran en el manual de instrucciones disponible para su referencia. Además, necesitará el recibo de su compra u otra prueba de compra. La(s) pieza(s) de reemplazo le será(n) enviada(s) sin recargo por Bush Industries asumiendo los gastos de envío y manipuleo.

Todo mueble de Bush Business Furniture es garantizado al comprador original al momento de la compra y por un periodo de diez años en adelante.

Le garantizamos a usted, el comprador original, que nuestros muebles sus partes y componentes están libres de defectos en materiales o trabajo. "Defectos", según se usa en esta garantía, se define como una imperfección que perjudica el uso del producto mobiliario.

Nuestra garantía se limita expresamente al reemplazo de partes y componentes mobiliarios. Durante diez años después de la fecha de compra, Bush reemplazará cualquier parte defectuosa en material o trabajo.

Esta garantía se aplica bajo condiciones de uso normal. Nuestros productos de Bush Business Furniture no son para uso en exteriores. Esta garantía no cubre: 1) defectos causados por un ensamblaje o desensamblaje inadecuado; 2) defectos que ocurran después de la compra debido a modificación del producto, daño intencional, accidente, mal uso, abuso, negligencia o exposición a los elementos; y 3) costos de trabajo o ensamblaje.

LAS GARANTÍAS IMPLICADAS, INCLUYENDO LA GARANTÍA DE COMERCIABILIDAD, NO SE EXTENDERÁN MÁS ALLÁ DE LA DURACIÓN DE LA GARANTÍA ESCRITA MENCIONADA, Y EN NINGUN CASO BUSH SERÁ RESPONSABLE POR DAÑOS INCIDENTALES O CONSIGUIENTES COMO RESULTADO DEL USO DEL PRODUCTO. Algunos estados no permiten una limitación sobre el tiempo de duración de la garantía implicada o la exclusión o limitación de daños incidentales o consiguientes, de manera que la limitación y exclusión mencionadas pueden no aplicarse para usted.

Esta garantía le otorga derechos legales específicos. Puede también tener otros derechos que pueden variar según los estados.

### PLEASE RETAIN THIS FOR YOUR RECORDS/VEUILLEZ CONSERVER CECI POUR VOS ARCHIVES/POR FAVOR CONSERVE ESTE DOCUMENTO PARA SUS REGISTROS

You may need to refer to this information in case of warranty claim for insurance purposes.

Il se peut que vous ayez besoin de ces informations en cas de réclamation de garantie pour votre assurance.

Puede necesitar referirse a esta información, en caso de algún reclamo de la garantía con fines relacionados al seguro.

Date Purchased/Date d'achat/Fecha de la Compra: \_\_\_\_\_

Store Name/Nom du magasin/Nombre de la Tienda: \_\_\_\_\_

Model #/Modèle #/Modelo #: \_\_\_\_\_

Product Description/Description du produit/Descripción del Producto: \_\_\_\_\_

Lot Code: \_\_\_\_\_