

Insert and loosely tighten all screws. When assembly is completed, fully tighten all screws before using. This chair is only intended for sitting. Any other use will void the warranty.

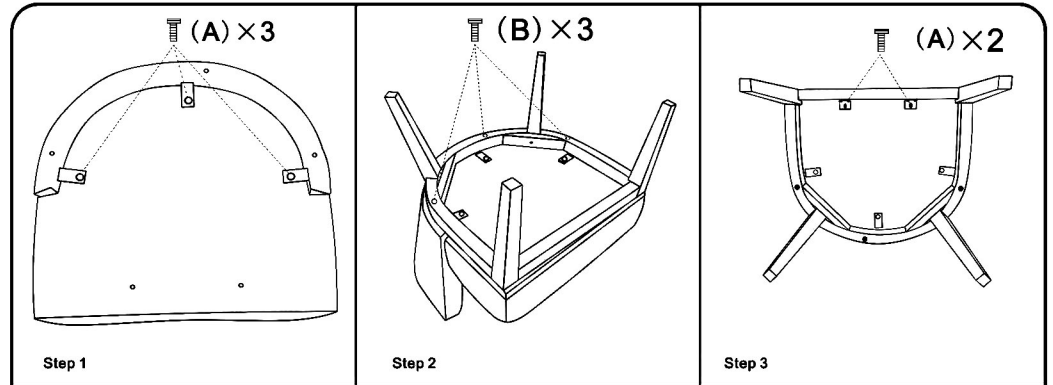







MODEL : B529

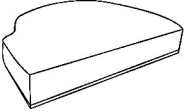
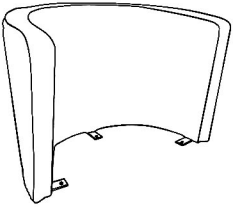
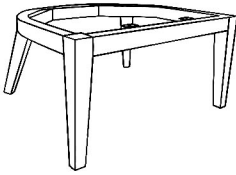

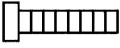
Step 1
Attach back to seat.

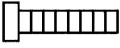
Step 2
Attach frame with legs to seat.

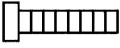
Step 3
Attach 2 front brackets to seat.

Seat Cushion	Back Cushion	Frame wood ×1									
											
<table> <tr> <td data-bbox="197 1267 318 1305">(A) × 5</td> <td data-bbox="360 1257 427 1305"></td> <td data-bbox="555 1267 689 1305">M6 × 25</td> </tr> <tr> <td data-bbox="197 1315 318 1353">(B) × 3</td> <td data-bbox="360 1315 479 1362"></td> <td data-bbox="555 1315 689 1353">M8 × 45</td> </tr> <tr> <td data-bbox="197 1362 318 1401">(C) × 1</td> <td data-bbox="360 1362 472 1410"></td> <td data-bbox="555 1362 721 1401">Allen Key</td> </tr> </table>			(A) × 5		M6 × 25	(B) × 3		M8 × 45	(C) × 1		Allen Key
(A) × 5		M6 × 25									
(B) × 3		M8 × 45									
(C) × 1		Allen Key									

Customer Service Hotline: 1-800-593-1888

For further assembly instructions,

please visit our website at www.bosschair.com

