









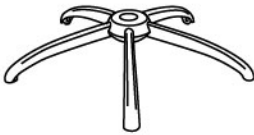

**IMPORTANT NOTICE:
HARDWARE PACKAGE IS ATTACHED
ON THE BOTTOM OF SEAT CUSHION.**

MODEL: B436

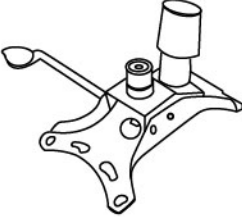
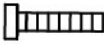
(1)X1  BACK	(2)X1  SEAT	(3)X2  ARMS
(4)X1  GAS LIFT	(5)X1  BASE	(6)X5  CASTERS
(7)X1  MECHANISM	<p>(A)X4  M8*45 ARM SCREW</p> <p>(B)X4  M8*22 MECHANISM SCREW</p> <p>(C)X4  M8*30 L-BAR SCREW</p> <p>(D)X4  ARM CAPS</p> <p>(E)X1  ALLEN KEY</p>	

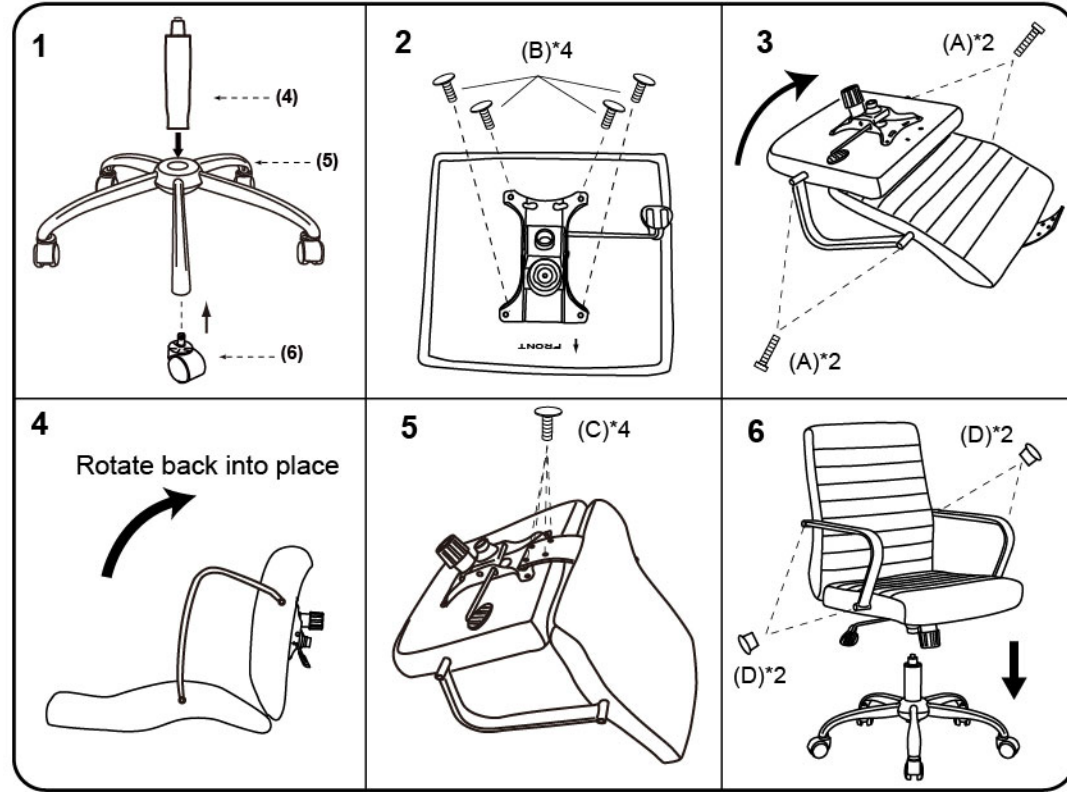

Insert and loosely tighten all screws. When assembly is completed, fully tighten all screws before using. This chair is only intended for sitting. Any other use will void the warranty.



Customer Service Hotline: 1-800-593-1888 For further assembly instructions, please visit our website at www.bosschair.com