









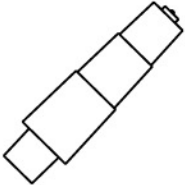

Please unscrew mechanism and L-bar hardware from cushion before assembly.

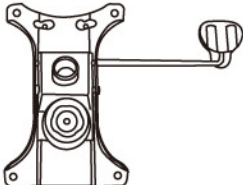
Por favor de destornillar todos los tornillos del cojín antes de ensamblar la silla.

MODEL : B726

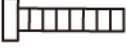
(1)x1  Back Cushion	(2)x1  Seat Cushion	(3)x1 (L)x1 (R)  Left-Arm-L Right-Arm-R
(4)x1  Gas Lift W/ Cover	(5)x1  Base	(6)x1  Mechanism
(7)x5  Caster		
(A)x4  M8 X 22 MECHANISM SCREW		
(B)x4  M8 X 30 L-bar SCREW		
(C)x4  M8 X 45 ARM SCREW		
(D)x4  ARM CAPS		

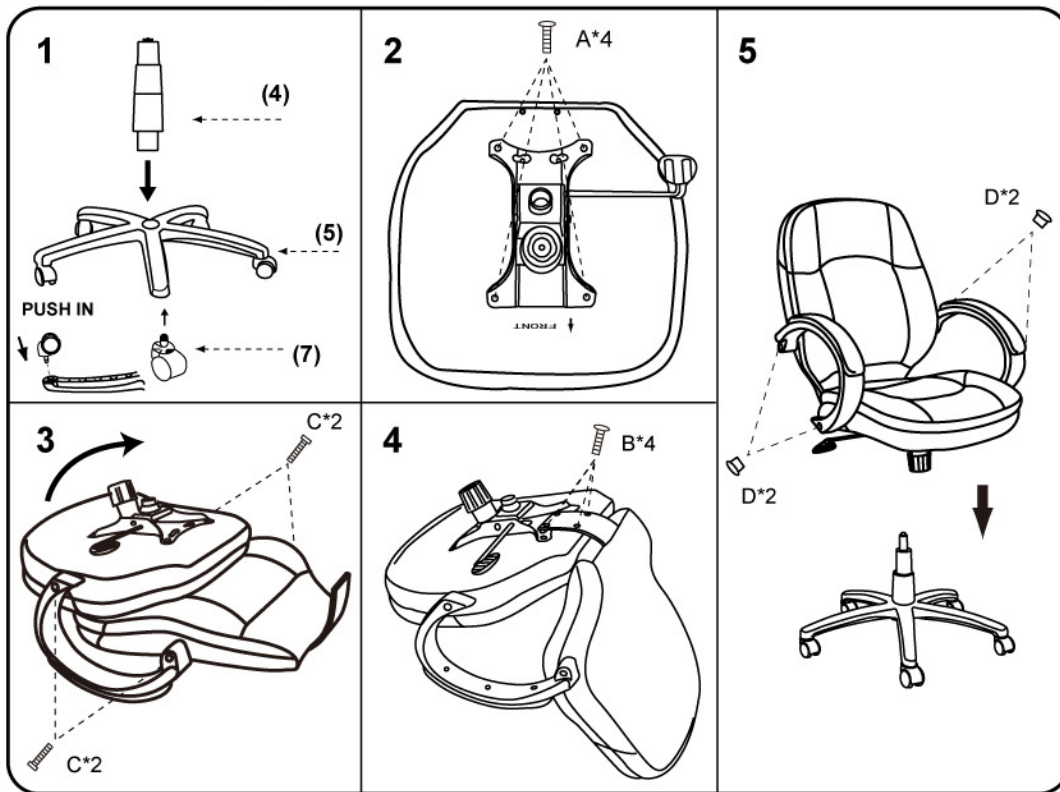

Note: Please tighten all arm screws using allen key before step 5

Insert and loosely tighten all screws. When assembly is completed, fully tighten all screws before using. This chair is only intended for sitting. Any other use will void the warranty.

