







Please unscrew all hardware from cushion before assembly.
Por favor de destornillar todos los tornillos del cojín antes de ensamblar la silla.

MODEL : 6406

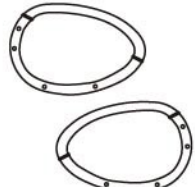
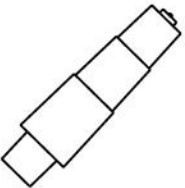
(1)x1  Back Cushion	(2)x1  Seat Cushion	(3)x1 (L)x1 (R)  Left-Arm-L Right-Arm-R
(4)x1  Gas Lift W/ Cover	(5)x1  Base	(6)x1  Mechanism
(7)x5  Caster		

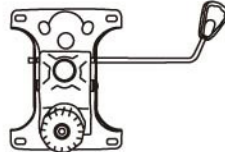
- (A)x4  **M8 X 22 Mechanism Screws**
- (B)x8  **M6 X 25 Arm Screws**
- (C)x1  **ALLEN KEY (Provided in separate bag)**

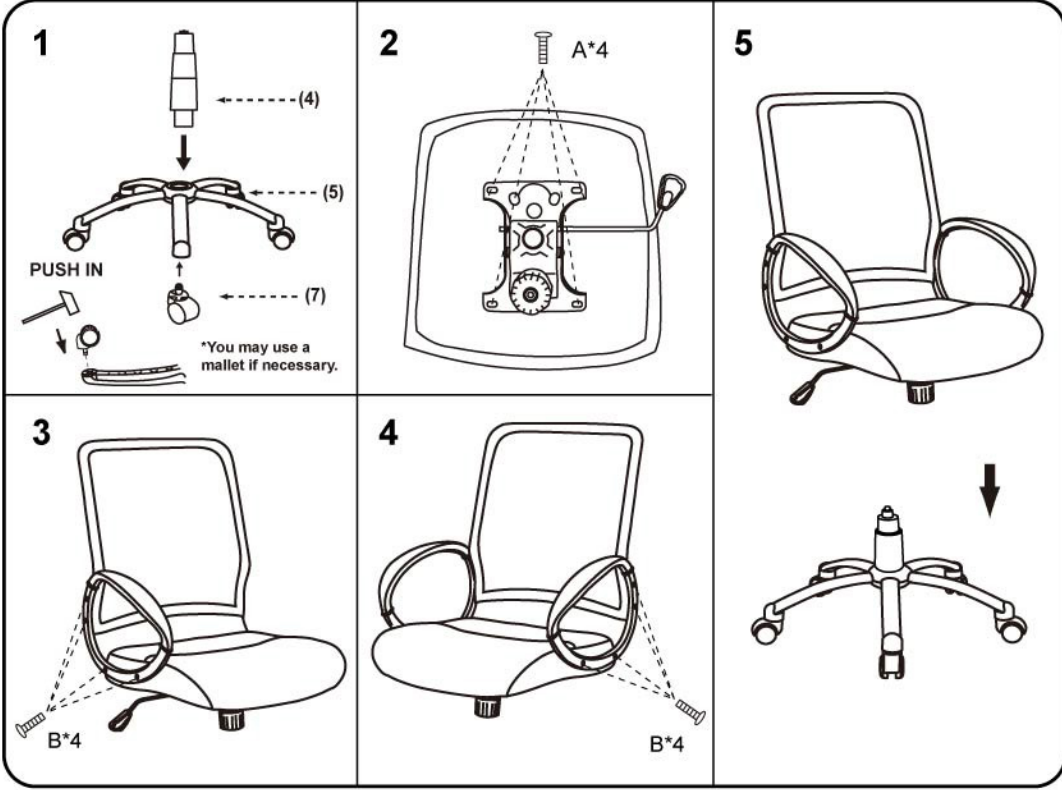

Insert and loosely tighten all screws. When assembly is completed, fully tighten all screws before using. This chair is only intended for sitting. Any other use will void the warranty.



Customer Service Hotline: 1-800-593-1888
For further assembly instructions,
please visit our website at www.bosschair.com

