







Please unscrew hardware for the arms from cushion before assembly.
Por favor de destornillar todos los tornillos del cojín antes de ensamblar la silla.

MODEL: B3035 3036 3037 B3045 3046 3047

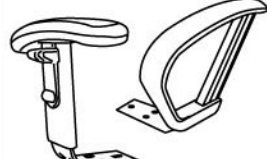
(1)x1	(2)x1	(3)x1 (L)x1 (R)
		
Back Cushion	Seat Cushion	Left-Arm-L Right-Arm-R
(4)x1	(5)x1	(6)x5
		
Gas Lift W/ Cover	Base	Caster
<p>(A)x6  M6 X 30 Arm Screws</p>		

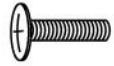
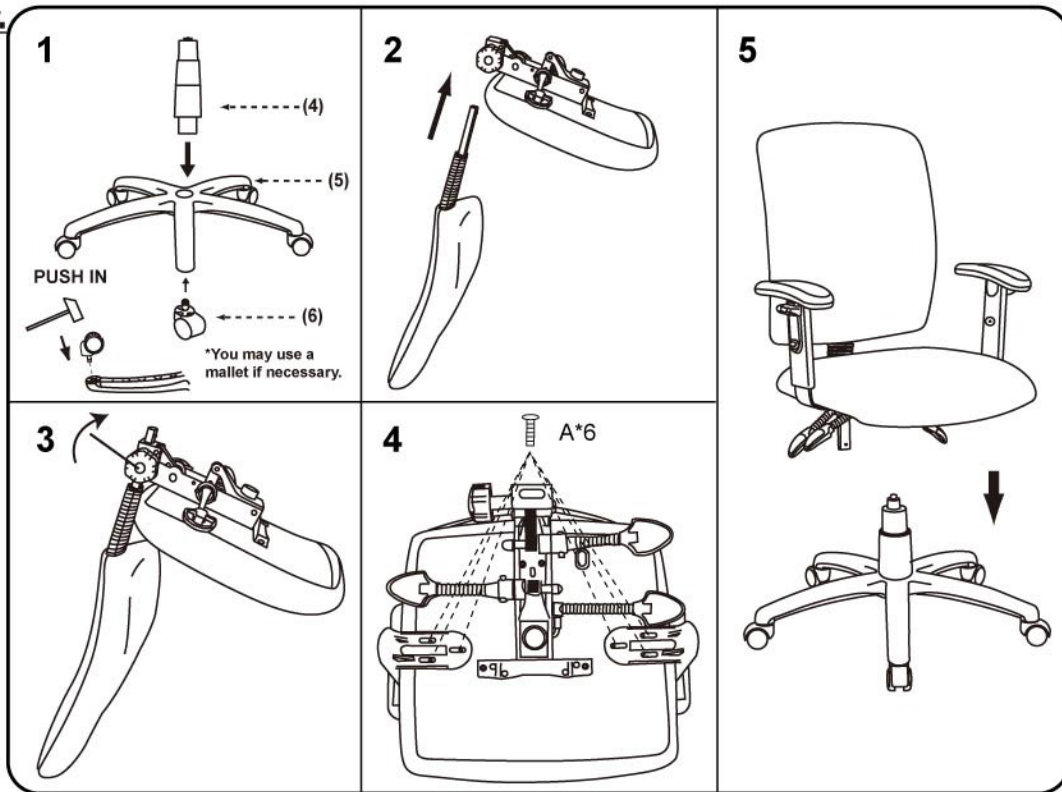

Insert and loosely tighten all screws. When assembly is completed, fully tighten all screws before using. This chair is only intended for sitting. Any other use will void the warranty.

Customer Service Hotline: 1-800-593-1888
For further assembly instructions,
please visit our website at www.bosschair.com

