

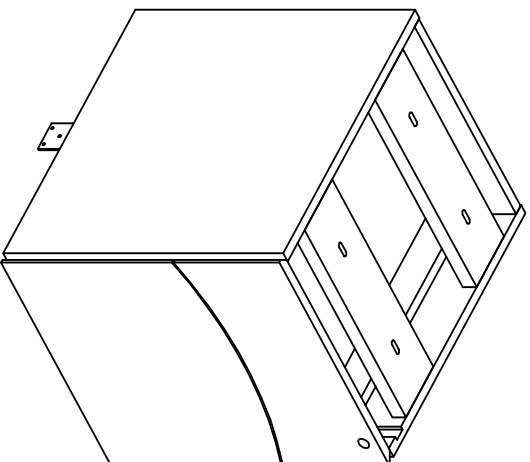





**Brighton Series™
Suspended Pedestal
Model No. BTBF20**

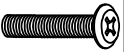

ASSEMBLY INSTRUCTIONS
CALL 1-800-822-8037 FOR ASSISTANCE

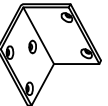
P/N **BTBF20** Rev.2 03/10

PARTS LIST

Name	Part	Qty.	Spare Qty	Name	Part	Qty.	Spare Qty
A	 REALBY014 M6 x 45mm HB	4	1	E	 REALBY033 Spring Lock Washer HB	4	1
B	 REALBY024 Corner Bracket HB	1			 Keys		
C	 REALBY009 M3.5 X 14mm Black HB	5	1		 BTBFHB		
D	 REALBY032 Washer HB	4	1				

Items with HB are in hardware box.

1

1

Remove drawers from pedestal by depressing the plastic tabs and pulling the drawer out of cabinet.

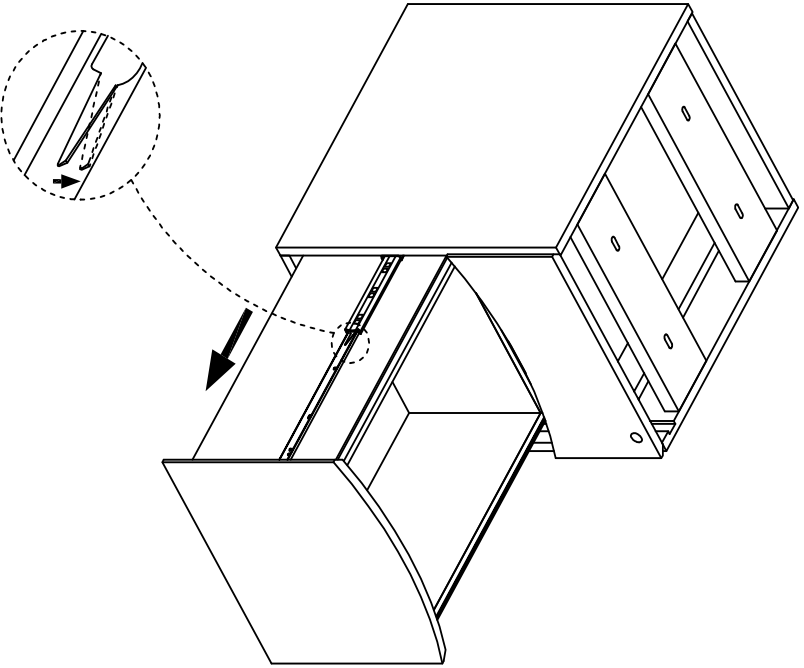

2

2

Turn Pedestal over and center Angle (B) on the "UNDERSIDE" of pedestal along the edge that will come in contact with the desk leg. Attach Angle (B) using Screws (C).

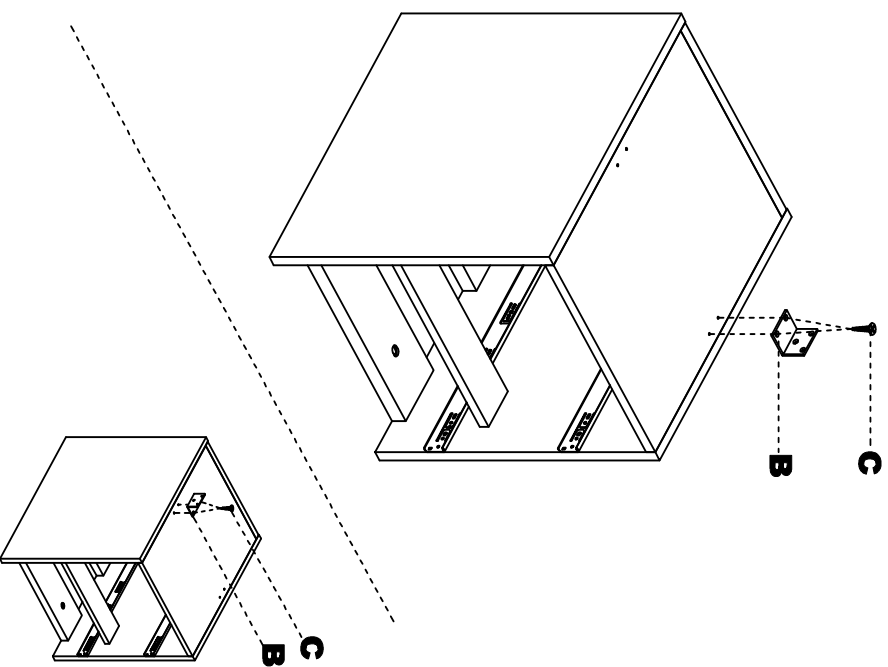

3

3 Attach Pedestal with Screws (A), Lock Washers (E) and Washers (D) using inserts in the underside of the Top. Secure Angle (B) to the desk leg using Screws (C).

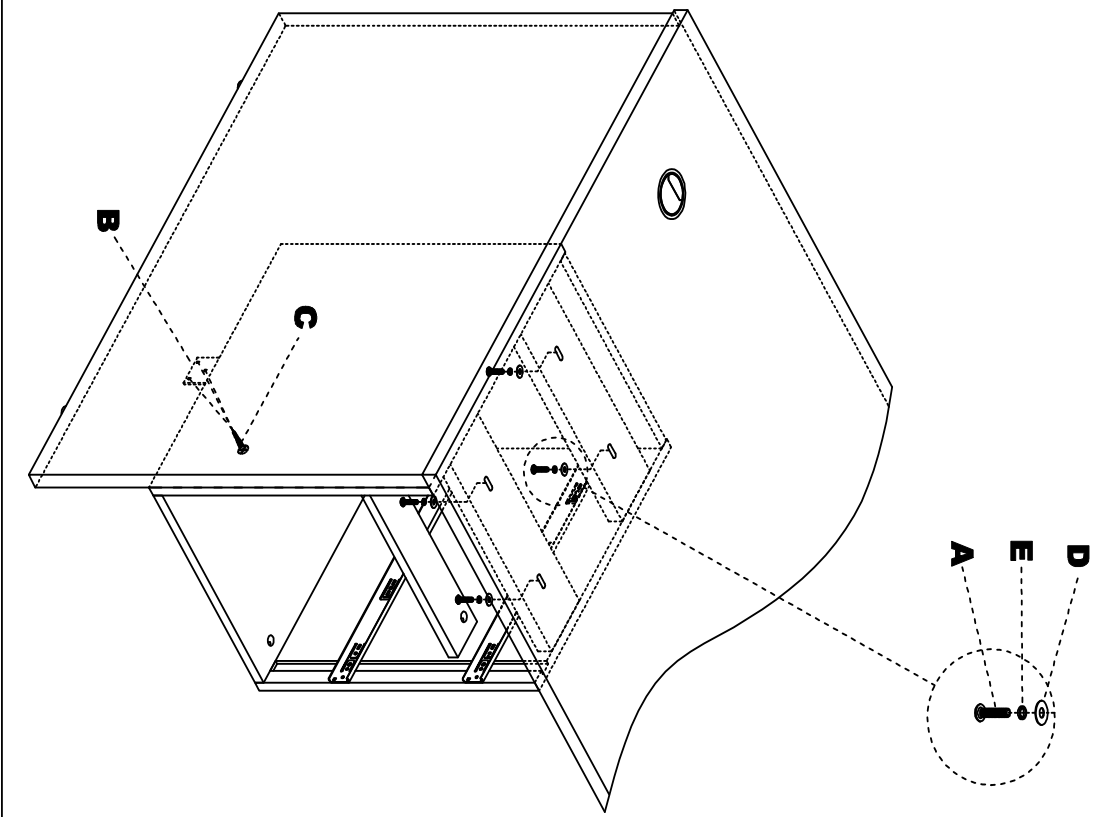

4 Re-install the drawers into the pedestal by lining up the grooves of the inner slide with the grooves of the outer slides and sliding in.

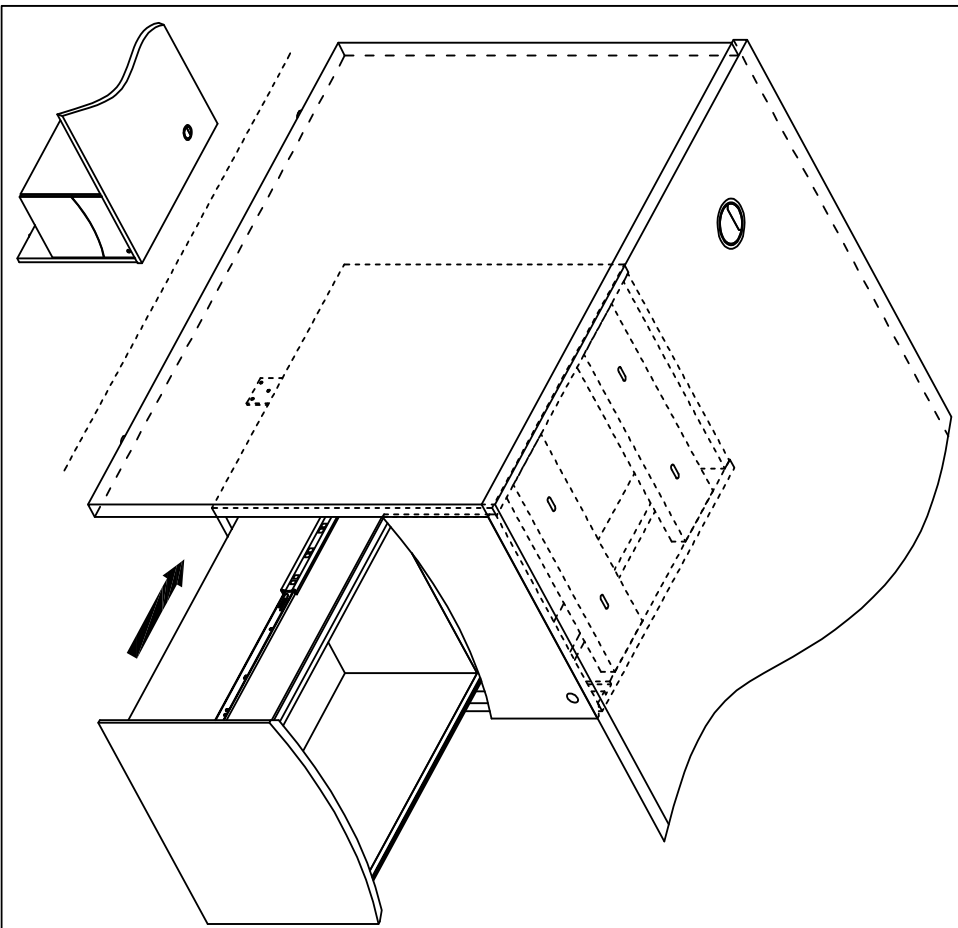

5 Use Drawer sides for letter size filing. Install File Bar Clips and File Bars for legal size filing only.

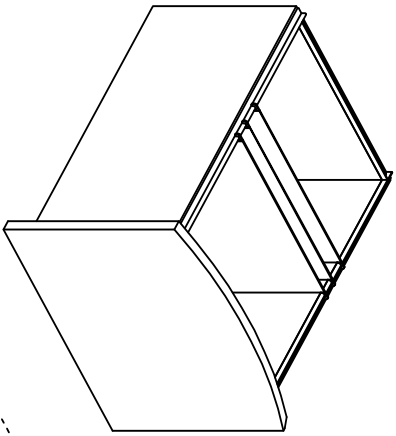



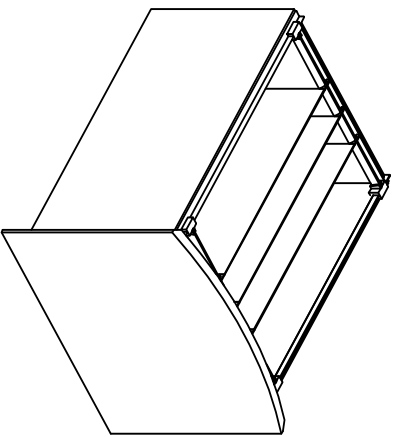



Letter Sized Filing



Legal Sized Filing

6

Pre-Installed Replacement Parts List

Part	Included Qty.	Part	Included Qty.
 REALBY038 18" Slide Pair, File Drawer	1	 REALBY040 18" Slide Pair, Box Drawer	1
 BTBFD*** Drawer Fronts, Set of 2	1	 REALBY009 M3.5 x 14 Black	50
 REALBY029 File Bar Clip	4	 REALBY030 File Bar	2
 TCC0001 Lock	1		

**Denotes Color Code

7